

1970-1971

TRIUMPH  
TRIUMPH  
TRIUMPH  
TRIUMPH

**TRIUMPH**



NORTH AMERICAN EDITION

**handbook**

IMPORTANT

IN THE INTERESTS OF SAFETY, THE IMPORTANCE OF MAINTAINING CORRECT TIRE PRESSURES CANNOT BE OVEREMPHASISED. PRESSURES SHOULD BE CHECKED AT LEAST EVERY TWO WEEKS OR 1000 MILES, AND MAINTAINED IN ACCORDANCE WITH RECOMMENDATIONS GIVEN ON PAGE 23

**TRIUMPH**

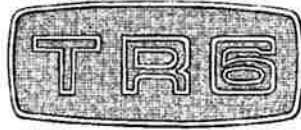

**OWNER'S HANDBOOK**

*Issued by*  
**STANDARD-TRIUMPH SALES LTD**  
**COVENTRY, ENGLAND**

*A member of the British Leyland Motor Corporation*



**TRIUMPH TR6**

# Introduction

**D**ESIGNED AND BUILT to give long and consistent trouble-free service, your TR6 embodies many new safety features, the very presence of which will add to your confidence.

*Read carefully the contents of this book which gives, in the simplest possible terms, information vital to the proper operation, care and regular maintenance of the car.*

*The TR6 complies with, and in many cases exceeds, all current Federal and State Regulations concerning Safety, Engine Crankcase Emission and Fuel Evaporative Control.*

*Because of these regulations, owners are strongly urged to make use of the Maintenance Voucher Scheme operated by Triumph Dealers and described in a separate booklet supplied with the car. This will assure the emission control system is correctly serviced by trained personnel.*

3

## *Important*

In all communications relating to Service or Spares, please quote the Commission Number (Chassis Number) Paint and Trim Numbers

### LOCATION OF COMMISSION AND UNIT NUMBERS

Note. L.H. and R.H. refer to Left-hand and Right-hand side of the vehicle viewed from the driving position.

Commission, Paint and Trim Numbers—On Scuttle Panel (May be seen by lifting the bonnet)

Engine Number—On L.H. side of Cylinder Block

Gearbox Number—On L.H. side of Housing

Rear Axle Number—On Hypoid Housing Flange

### STANPART

#### Spare Parts Service

Replacement parts are not supplied from the factory direct to the general public, but are directed through Distributors who, in turn, supply their Dealers.

Genuine spare parts are marketed under the trade mark "Stanpart" and carry the same guarantee as the original part. The same high quality material is used and the strictest accuracy maintained during manufacture. You are advised, therefore, to insist on the use of these parts should replacements be necessary. Remember, parts which do not carry the trade mark "Stanpart" will invalidate the guarantee if fitted to your vehicle.

The descriptions and illustrations appearing in this book are not binding. The MANUFACTURER, therefore, reserves the right — whilst retaining the basic features of the Models herein described and illustrated — to make at any time, without necessarily bringing this book up-to-date, any alteration to units, parts or accessories deemed convenient for improvement or for any manufacturing or commercial reason.

4

*List  
of  
Sections*

	Page
Introduction .. .. .	3
Location of unit numbers .. .. .	4
Controls, Instruments and Indicators .. .. .	6
Safety Harness .. .. .	14
Seats .. .. .	16
Locks and Keys .. .. .	17
Soft Top .. .. .	18
Hard Top .. .. .	21
Care of Bodywork .. .. .	22
Wheel and Tires .. .. .	23
Cooling System .. .. .	27
Electrical System .. .. .	30
Driving Recommendations .. .. .	39
Routine Servicing .. .. .	41
Emission and Control Evaporation System .. .. .	42
Periodic Checks .. .. .	45
1,000 Mile Free Service .. .. .	47
Regular Maintenance .. .. .	48
Recommended Lubricants .. .. .	63
Maintenance Chart .. .. .	64
General Specification .. .. .	66
Index .. .. .	70

**CONTROLS, INSTRUMENTS AND INDICATORS**

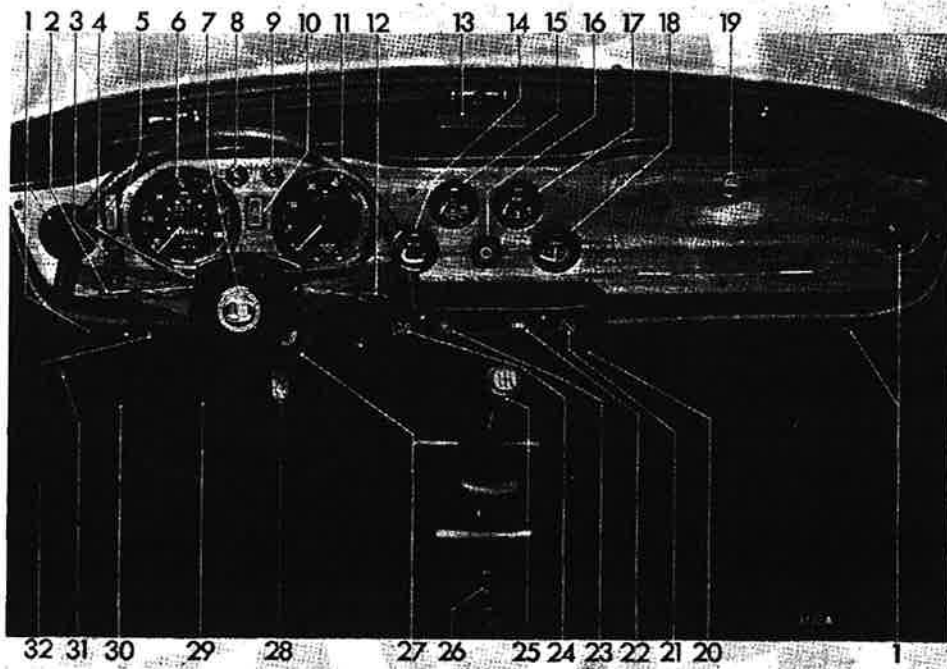

Fig. 2

**KEY TO FIG. 2**

- |                                 |                                      |                                   |
|---------------------------------|--------------------------------------|-----------------------------------|
| 1. Fresh-air vent               | 14. Temperature gauge                | 26. Parking-brake lever           |
| 2. Turn-signal control          | 15. Oil pressure gauge               | 27. Ignition/steering column lock |
| 3. Windshield washer switch     | 16. Instrument illumination rheostat | 28. Throttle pedal                |
| 4. Overdrive switch (optional)  | 17. Fuel gauge                       | 29. Brake pedal                   |
| 5. Windshield wiper switch      | 18. Ammeter                          | 30. Clutch pedal                  |
| 6. Speedometer                  | 19. Glove-box lock                   | 31. Headlight dipper              |
| 7. Horn-push                    | 20. Scuttle-vent control             | 32. Trip zero control             |
| 8. Hazard warning indicator     | 21. Choke control                    | 33. High-beam indicator           |
| 9. Brake-line failure indicator | 22. Heat control                     | 34. Turn-signal indicator         |
| 10. Hazard warning switch       | 23. Blower switch                    | 35. Low oil pressure indicator    |
| 11. Tachometer                  | 24. Air distribution control         | 36. No-charge indicator           |
| 12. Lighting switch             | 25. Gear shift lever                 | 37. Odometer                      |
| 13. Ashtray                     |                                      | 38. Trip odometer                 |

Refer to Fig. 6

**CONTROLS, INSTRUMENTS AND INDICATORS**

**CONTROLS, INSTRUMENTS AND INDICATORS**

The controls, instruments and indicators shown on Figs. 2 and 6 and described in the following pages are positioned within easy reach of the driver to afford maximum ease of operation and minimum distraction. The bracketed figures in the text cross-refer with the key on page 7.

**Fresh-Air Vents (1)**

The swivelling vents can be adjusted to admit cold air only in any chosen direction within the limits of movement. Each vent incorporates a valve, operated by a knob in the center of the vent. To diminish or shut off the supply of air, turn the knob clockwise. The air flow may be boosted by use of the blower motor (See item 23).

**Turn Signal Control (2)**

Move the control lever upwards to operate the right-hand turn-signal lights or downwards to operate the left-hand turn-signal lights.

**Windshield Washer Switch (3)**

Depress the upper portion of the switch to spray clean fluid onto the windshield and switch on the wipers to disperse the mud. The washer switch will operate only when the ignition switch is turned 'ON'.

**Overdrive Switch (4) (Optional)**

When an overdrive unit is fitted to the vehicle the operating switch is mounted on the left-hand side of the steering column. Move the lever up to engage the overdrive and down to release it. Before using the control, refer to page 40.

**Windshield Wiper Switch (5)**

Depress the upper portion of the switch to operate the wipers at slow speed, or depress the lower portion to operate them at high speed. Select the mid-position to switch off, when the wipers will automatically return to the parked position at the base of the windshield. The wipers will operate only when the ignition switch is turned 'ON'.

**Speedometer (6)**

In addition to indicating the road speed of the vehicle in miles and kilometres per hour, the instrument also combines the turn signal and high beam warning lights and the total and trip odometers.

## CONTROLS, INSTRUMENTS AND INDICATORS

### Horn Push (7)

Press to operate the horns.

### Hazard Warning Indicator (8)

When the 'hazard warning switch' (10) is operated the indicator will flash in unison with the exterior warning lights.

### Brake-line Failure Indicator (9)

When the ignition switch is turned on the "brake line failure" and "low oil pressure" indicator lights glow faintly and are extinguished when the engine is running. Should the failure of the front or rear brake lines occur, the indicator (9) will glow brightly.

A broken bulb filament is indicated by the warning light failing to glow when the ignition is turned on, before starting the engine.

### Hazard Warning Switch (10)

If the vehicle is immobilised and constitutes a hazard to other vehicles, warning may be given by using the "hazard warning system". To operate, depress the lower portion of the switch (10) when all turn-signal lights will flash intermittently.

### Tachometer (11)

The tachometer indicates the engine speed in revolutions per minute and combines two warning indicators (35, 36. See Fig. 6). The speed range within the colored segments is subject to the "Recommended Speed Limits" mentioned on page 40.

### Lighting Switch (12)

Move the lever downwards to the first position to illuminate the rear tail, license plate, parking lights and side marker lights. Move the lever down to the second position to illuminate the headlights. (See "Headlight Dipper" 31).

Lifting the lever towards the steering wheel flashes the headlight high beams.

### Ashtray (13)

An ashtray is provided in the center of the facia top. To empty, lift the assembly from the surround.

### Temperature Gauge (14)

When the ignition switch is turned 'ON' the pointer moves slowly across the dial taking up to one minute to reach a true reading.

Normal operating temperature is reached when the pointer registers in the central sector of the dial. Should the pointer reach the highest mark, stop the engine immediately and check the level of coolant in the radiator. Refer to page 28.

### Oil Pressure Gauge (15)

Oil pressure at 2,000 r.p.m. under normal operating conditions, should be 45-65 lbs./sq. in. Severe operating conditions, such as competition work, may cause the oil pressure to drop below 25 lb./sq. in., indicating that the oil temperature is excessive. Under these circumstances fitment of an oil cooler may be necessary.

9

## CONTROLS, INSTRUMENTS AND INDICATORS

### Instrument Illumination Rheostat (16)

Turn the knob clockwise to illuminate the instruments. Further rotation of the knob diminishes the light intensity—operates only when the lighting switch is 'ON'.

### Fuel Gauge (17)

The fuel gauge indicates the approximate contents of the fuel tank. When the ignition switch is turned 'ON' the pointer moves slowly across the dial taking up to one minute to reach a steady reading which it will maintain regardless of vehicle movement, until the ignition is switched 'OFF'.



Fig. 3

### Ammeter (18)

The ammeter indicates the rate of battery charge or discharge. The charging rate is indicated when the pointer moves to the left-hand side of 'Zero' and discharge, by movement to the right.

### Glove Box Lock (19)

The glove-box may be unlocked by turning the key a quarter turn clockwise and opened by depressing the locking barrel.

### Scuttle Vent Control (20)

Fresh air is admitted to the heater duct through the open scuttle ventilator (Fig. 3). This is opened by pulling the lever (20) rearwards and closed by pushing it forwards. When the ventilator is closed, the heater unit recirculates air already in the vehicle.

### Choke Control (21)

This control is used to enrich the fuel mixture for easy starting from cold. The control should not be used if the engine is warm, and may not be necessary in warm climates. Full instructions for use are given on page 39.

### Ignition, Starter and Steering Lock Switch (27)

The combined ignition/starter/steering lock switch is operated by a special key.

Incorporated in the switch is a "Key Warning System". The alarm system is fitted to encourage the driver to remove the ignition key from the lock before leaving the vehicle.

Separate keys are supplied for locking the driver's door. The switch has four positions (Fig. 4) as follows:

## CONTROLS, INSTRUMENTS AND INDICATORS

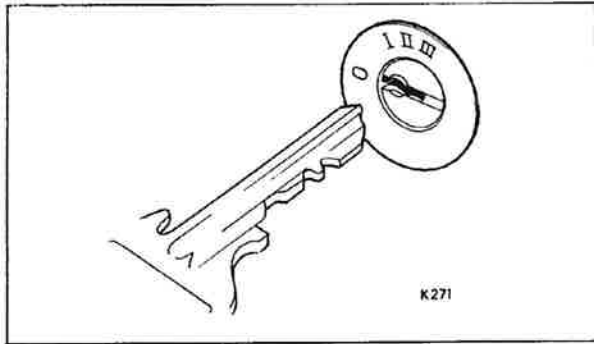

Fig. 4

- 0 "OFF" in which position the key may be inserted or withdrawn (see Key Warning System).
- I "Auxiliary", in this position the ignition circuit is isolated to allow the use of a radio when the vehicle is stationary and the ignition is switched off.
- II "Ignition" (see ignition warning).
- III "Start" (Refer to "Starting the engine" on page 39).

Turn the key clockwise to II (Ignition) the ignition will be switched on.

To start the engine, the key should be turned a little more against spring pressure to III ("start"), as soon as the engine fires release the key which will return automatically under spring pressure to the ignition position (II).

### 1. To stop engine and engage steering lock

Turn the key in an anti-clockwise direction from the "ignition" position (II) to the "lock" position (0). This action stops the engine.

Removal of the key in this position automatically actuates the steering lock mechanism. (See Key Warning System).

The Key Warning System only functions when the ignition key is positioned in the switch and the driver's door is open. The "warning" denoted by a continuous buzzing sound will terminate when the driver's door is closed or the ignition key is completely removed. (See page 38).

### 2. To disengage Steering Lock and Start Engine

Insert the key and turn in clockwise direction. If difficulty is experienced in turning the key, this can be rectified by simultaneous movement of the steering wheel.

11

## CONTROLS, INSTRUMENTS AND INDICATORS

### Heat Control (22)

The heat control operates a water valve which regulates the flow of water through the heater unit. The control may be set at any intermediate position as required. The water valve is closed when the control is pushed in; maximum heat is available when the control is pulled out.

### Blower Switch (23)

The blower motor boosts the flow of air through the heater unit. Pull the switch to its first position to operate the blower motor at slow speed or to its second position for high speed operation. The blower will operate only when the ignition switch is turned 'ON'.



Fig. 5

### Air Distribution Control (24)

The air distribution control operates a 'flap' valve which directs air from the heater unit to the windshield or to the windshield and interior. The maximum volume of air is directed to the windshield (for de-misting and de-frosting) when the control is pulled halfway out. When the control is pulled fully out, air is distributed to the interior and to the windshield. The 'flap' valve is closed when the control is pushed fully in.

### Gear Shift Lever (25)

Moving the gear shift lever from neutral, the gear positions are as follows:

1st	..	..	Move the lever left and forward
2nd	..	..	Move the lever left and rearward
3rd	..	..	Move the lever right and forward
4th (top)	..	..	Move the lever right and rearward
Reverse	..	..	Move the lever sharply to the extreme right and rearward. Engage only when the vehicle is stationary.

Always select neutral before starting the engine.

### Parking Brake Lever (26)

To apply the rear wheel brakes pull the parking brake lever upwards. To release the brakes, pull the lever slightly upwards, depress the button (arrowed, Fig. 5) and lower the lever while the button is depressed.

## CONTROLS, INSTRUMENTS AND INDICATORS

### Throttle, Brake and Clutch Pedals (28, 29 and 30)

These are conventional items which should require no further explanation.

### Headlight Dipper (31)

When the headlights are illuminated (see 'Lighting Switch' on page 9), the high beams may be lowered by pressing the dipper switch and releasing it. To return to the high beam position, again press the dipper switch and release it. The high beam position is indicated by a blue warning light (33) near the bottom of the speedometer dial.

### Trip Zero Control (32)

The trip odometer (38) may be reset to zero by pushing the knob (32) upwards and turning clockwise.

### High Beam Indicator (33, Fig. 6)

The indicator glows blue when the headlight high beams are selected and is extinguished when the headlights are 'dipped'.

### Turn Signal Indicator (34)

Indicates the correct functioning of the turn signal lights when operated by the lever (2). A broken filament in a bulb on one side of the vehicle is denoted by the non-operation of the indicator light when the lever is in the relevant operating position. A defective flasher unit or broken filament in the indicator bulb will be indicated by no light response from the lever in both directional positions.

### Low Oil Pressure Indicator (35, Fig. 6)

The center indicator glows green when the ignition is switched on and is extinguished when the engine runs in excess of idling speed. Should the light remain on at normal running speeds, stop the engine and check the level of oil in the engine oil pan. If this is satisfactory, have the lubrication system checked immediately.

### No-Charge Indicator (36, Fig. 6)

The indicator glows red when the ignition is switched on and is extinguished when the engine is running. Should the red light remain on whilst driving, a fault is indicated in the battery charging system which should be rectified without delay.

### Odometer (37, Fig. 6)

The figures within the aperture below the center of the speedometer dial show the total mileage of the vehicle and may be used as a guide for periodic lubrication and maintenance.

### Trip Odometer (38, Fig. 6)

The figures within the aperture above the center of the speedometer dial may be used to record the distance of each journey, provided that the figures are initially set at zero. (See 'Trip Zero Control', 32.)

### Interior Lamp

The interior lamp mounted on the transmission tunnel is operated automatically when either door is opened, or manually by the switch located on the unit.

13

## CONTROLS, INSTRUMENTS AND INDICATORS

### Radio Controls

For operating instructions see the radio leaflet provided with the set.

### Sun Visors

Two adjustable sun visors, padded to reduce the risk of impact injury, may be unclipped from the centre support brackets and swung to eliminate side glare. The passenger's sun visor incorporates a vanity mirror.

### Rear View Mirror

The anti-glare device incorporated in the rear view mirror is operated by moving downwards the lever located on the rear of the mirror.

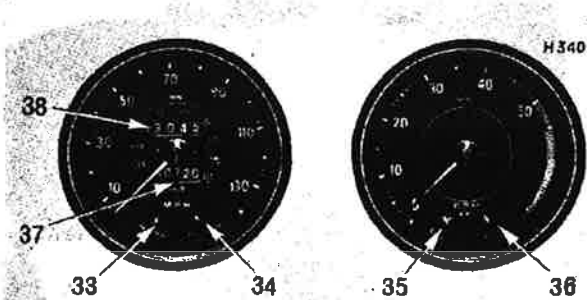

Fig. 6

14

## SAFETY HARNESS

Safety harness anchorage points built into the vehicle are shown on Figs. 7 and 8.

### Fitting the Harness

Remove the shoulder strap anchor bolt, crimped washer and collar from each wheelarch; pass the bolt through the strap attachment, fit the crimped washer and collar, as shown on Fig. 9, and refit to the vehicle. Fit the latched hook of the lap strap to the eye bolt (Fig. 7), and note that the shoulder strap will have a half twist when fitted to the wheelarch.

### Using the Harness

Pass the buckle end of the belt around the hips and the shoulder strap over the shoulder adjacent to the door. Fasten the belt by pushing the locking plate into positive engagement with the buckle. This is denoted by a 'click'. To release the harness depress the center panel.



**Harness Adjustment**

The belt should be adjusted so that the hand will pass between the strap and the chest. The lap strap should be reasonably tight with the buckle resting on the hip nearer the center of the vehicle.

*Adjustment to lower half of belt:*

Relieve any tension on the belt and pull the belt over the roller in the buckle, the roller has a self-locking action which, once adjusted, will retain its position.

*Adjustment to upper half of belt:*

Pull the slide on the lower part of the lap strap upwards to shorten and downwards to lengthen.

**Cleaning**

Badly stained safety belts can be dry cleaned. The cleaner should be advised of the nature of staining. Belts subjected to normal soiling can be cleaned with soap, or detergents dissolved in hot water.

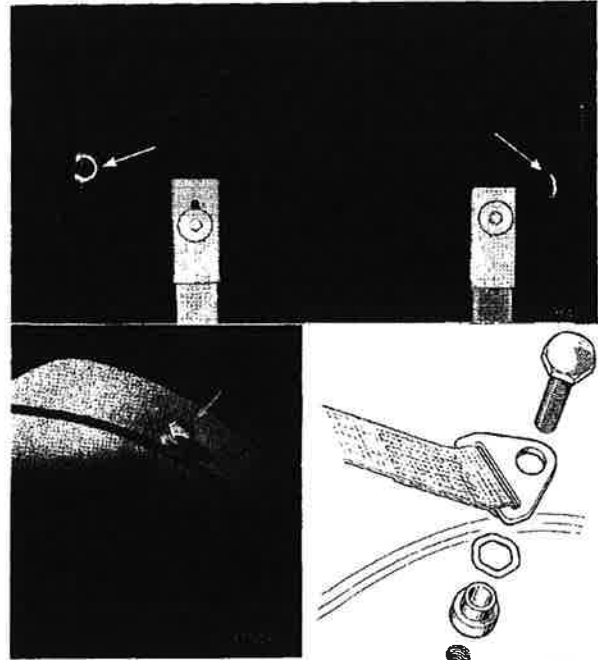

Fig. 7 (left)      Fig. 8 (upper)      Fig. 9 (right)

HC2B

**SEATS**

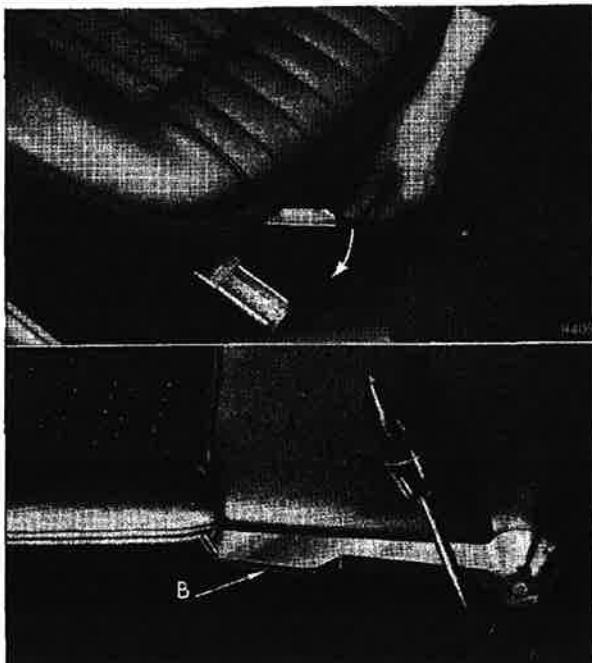

Fig. 10 (upper)      Fig. 11 (lower)

**SEATS**

The seats are of the bucket type and have rigid headrests to prevent the effects of backlash in an accident. The seats are pivoted at the front and secured at the rear by a spring loaded lever A (Fig. 11) which prevents the seat lifting during an accident. The lever, when lifted allows the seat to be tilted and access to be gained to the rear of the driving compartment.

To clean the seats refer to page 22 "Care of Bodywork".

**Adjustments**

The seats are adjustable for leg reach (fore and aft movement) and squab angle (back of the seat rake).

*Leg reach adjustment*

This is adjusted by moving the lever (Fig. 10) situated at the front of the seat and sliding the seat to the position required. Release the lever and try to slide the seat to ensure that the lever is correctly located and the seat is secure.

*Squab angle adjustment*

Sit in the seat, lift the lever B (Fig. 11) and assume the desired driving posture, the seat squab will automatically take up the correct position and the lever may be released.

**LOCKS AND KEYS**

**Keys**

The following keys are supplied with each new TR6.

- 3 Ignition keys.
- 2 Door keys.
- 2 Glove locker and trunk locker keys.

In addition, an ignition key identification disc is supplied and must be submitted to your Standard Triumph dealer when new ignition keys are required. As the disc is the only record of the ignition keys it should be kept in a safe place.

**Door Locks**

"Anti-burst" locks are fitted to both doors and are opened by a push button on the outside or by a remote control lever on the inside.

To lock a door from the inside, push the lever forward; to lock the door from the outside, insert the key and turn forward a quarter turn, the key will return under spring pressure and may be withdrawn.

**Ignition/Steering Lock and Key Warning System**

See page 11 for operation.

**Lubrication of Exterior Locks**

Once a month, particularly in sub-zero temperatures, apply a few drops of light machine oil to the latch and key slots. Do not apply grease to lock cylinders.

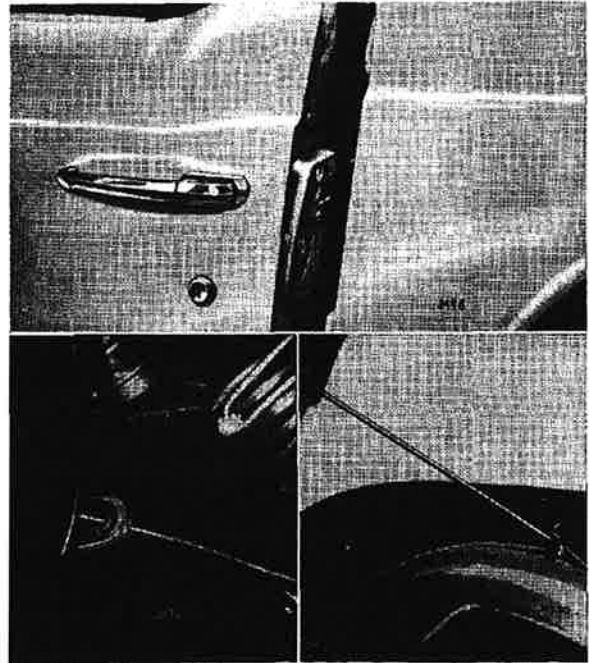

Fig. 12 (left)

Fig. 13 (upper)

Fig. 14 (right)

**SOFT TOP**

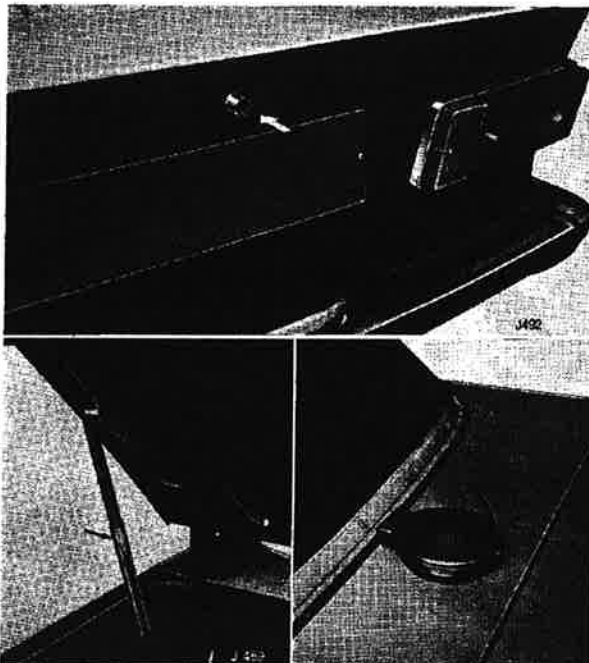

Fig. 15 (left)

Fig. 16 (upper)

Fig. 17 (right)

**Hood Release (Fig. 12)**

To open the hood pull the control situated below the left-hand side of the fascia. The hood will rise sufficiently to enable the fingers to be inserted under the rear edge to give access to the safety catch. The hood can then be released and raised to a near vertical position, where it will be supported by a stay. Disengage the stay from its recess before attempting to close the hood.

**Trunk Locker (Fig. 16)**

To open the deck lid, depress the unlocked plunger and raise the lid to its limit before lowering it on to the telescopic support.

Close the lid by raising it slightly to release the catch (arrowed, Fig. 15) in the telescopic support, lower, and which may be locked, by turning the key a half turn counter-clockwise.

**Fuel Filler Cap (Fig. 17)**

The fuel filler cap, located forward of the trunk lid, is opened by lifting the side of the cap. Press the cap to close.

## SOFT TOP

The soft top is made from P.V.C. material, and is supported by a hinged frame. The assembly folds down into the rear of the car and is protected by a soft top cover.

**Lowering the Soft Top**

Release the soft top header rail from the windshield frame by turning the catch levers in the direction as shown in Fig. 18.



Fig. 18



Fig. 19

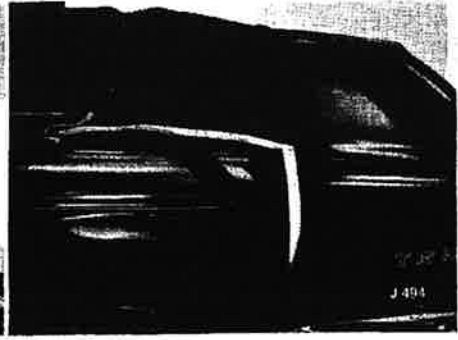

Fig. 20

Push the header rail, rearwards and slightly upwards, while knocking the soft top side support (arrowed Fig. 19) downwards, until the assembly begins to fold. Continue lowering the frame and pull the fabric flat over the deck lid (Fig. 20).

Fold the fabric forwards over the soft top frame and turn the ends of the fabric inwards (Fig. 21). Ensure, that the Vybak windows are free from distortion and that the fabric is clear of the frame.

19

## SOFT TOP

**Soft Top in the Down Position**

Retain the soft top in position by fitting the cover as follows:

Attach the cover to the outer fasteners and continue working towards the center. Attach each strap to its respective fastener on the back wall of the floor well.

**Raising the Soft Top**

Unfasten and remove the soft top cover. Fold the sides of the fabric outwards and pull rearwards over the deck lid. Lifting the front header rail, raise the assembly sufficiently to allow the

fabric to lie evenly over the soft top frame. Secure the fasteners (three each side, Fig. 22) to the body.

Secure the soft top header rail on the windshield frame, by turning the catch levers inwards towards the center of the car.

**Opening backlight (Fig. 23)**

To open the backlight, release the zip fastener and roll the panel downwards. Retain the rolled panel in position by attaching the straps to the press fasteners located on the back wall of the rear compartment.



Fig. 21



Fig. 22

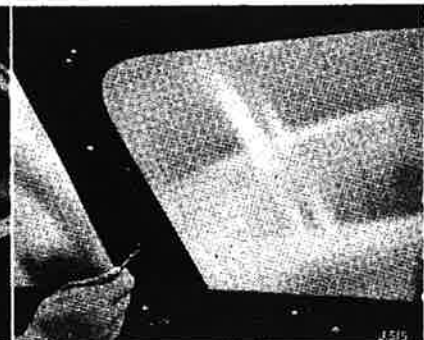

Fig. 23

20

**Tonneau Cover (Optional)**

The tonneau cover provides weather protection for the vehicle interior when the soft top is lowered. It incorporates press-studs for securing to the car and a zip fastener which permits access to either or both of the front seats.

**Hard Top (Optional) (Figs. 24, 25, 26)**

A hard top is available in kit form for fitment to soft top models, and may be removed and replaced as required.

Figs. 24 to 26 show the hard top attachments.

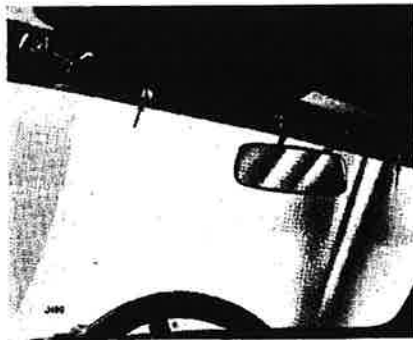

Fig. 24

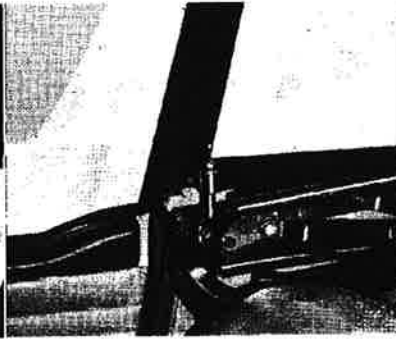

Fig. 25



Fig. 26

21

**CARE OF BODYWORK AND UPHOLSTERY****CARE OF BODYWORK****Washing**

Avoid using a dry cloth to wipe dust from the paintwork and plated surfaces. Dust is an abrasive and if removed in this way it will scratch the polished surfaces. Wash the vehicle frequently with plenty of running water and a clean soft sponge. Soften and, if possible, remove the mud with water before using the sponge. When all dirt is removed, sponge off and dry with a clean damp chamois leather. Never wash or polish the vehicle under a hot sun.

**Removing Grease and Tar**

Remove grease or tar by sparing use of white spirit, but do not apply this to rubber, particularly windshield wiper blades.

**Glass Surfaces**

Glass is easily scratched. This can be avoided by always using a damp chamois leather which is specially reserved for use on glass only. If silicone polishes have been used on the body, take care that the polish does not come in contact with the glass. It is extremely difficult to remove and causes the windshield wipers to smear.

**Chromium Plating**

Frequent washing and thorough drying is recommended, especially during the winter months when there is likelihood of corrosion through contamination with road salt.

**Polishing**

After a period of use, the formation of traffic film will cause the paintwork to lose some of its lustre, even though the vehicle has been carefully and regularly washed. The original brilliance may be restored after washing by using a reputable non-abrasive cleaner and polish.

Being the most durable, wax preparations are preferable, but where these are used regularly the old wax must first be removed with a cleaner before further application of new wax. The frequency at which polishing is necessary will depend upon local conditions of air pollution.

**Care of Interior, Soft Top and Tonneau Cover**

Brush and clean the inside of your car each time you wash and polish the outside of it. Use a vacuum cleaner where possible and ensure complete removal of all dust from the interior and trim.

Wash the Upholstery (and exterior fabric) with luke-warm non-caustic soapy water. Do not use detergents or household cleaners as these may cause damage. Remove all traces of suds with a clean damp cloth and thoroughly dry the upholstery with a dry duster or towel.

Wipe the facia and instrument panel with a damp cloth only. Wax or other polishes should not be used inside the car.

**Tires**

Wheels and tires, of correct types and pressures, are an integral part of a vehicle's design. Thus the regular maintenance of the tires contributes not only to the safety but to the designed functioning of the vehicle, as road holding steering and braking are especially vulnerable to the use of incorrectly pressurised, badly fitted or worn tires.

**Pressures**

Adjust tire pressures in accordance with the recommendations given below. These pressures are satisfactory for sustained speeds up to 112 m.p.h. (180 km.h.).

	Front	Rear
185 SR-15 G800	20 lb/in. <sup>2</sup>	24 lb/in. <sup>2</sup>
185 SR-15 X	(1.41 kg/cm <sup>2</sup> )	(1.69 kg/cm <sup>2</sup> )

**NOTE:** Should the vehicle be tuned to increase its maximum speed, or be used for racing, consult the respective tire company regarding the need for tires of full racing construction.

Never bleed a warm tire but always adjust the pressure whilst the tires are cold, i.e. before a run. As the tires warm up their pressures will increase.

To prolong tire life, avoid severe braking, sudden changes of direction at speed, and driving over or against high kerbstones, as this can result in severe damage to the tire walls. Examine the tires occasionally and remove flints or other road matter which may have become embedded in the treads.

**Cleaning**

Wipe off any oil or grease which may be on the tires by using a cloth moistened in gasoline. The tires should then be washed, using only soap and water.

**Tire Wear**

The characteristics of tires vary considerably and, therefore when new tires are fitted, all four tires must be of the same type and rating. (185-15 radial ply).

Occasionally remove flints and other road matter from the treads and examine the tires for sharp fins, flats and other irregularities. An upstanding sharp fin on the edge of each pattern rib is a sure sign of road wheel misalignment (Fig. 27).

Fins on the inside of the pattern ribs indicate toe-in. Fins on the outside edges indicate toe-out. Sharp pattern edges may also be caused by road camber, even when wheel alignment is correct. In such cases, it is better to make sure by having the track checked with an alignment gauge.

"Spotty" tread wear or flats, can result from grabbing brakes or unbalanced wheel assemblies. Your Triumph Dealer will check the action of the brakes and re-balance the tires if required. The original degree of balance is not necessarily maintained, and it may be affected by uneven tread wear, by repairs, by tire removal and refitting, or by wheel damage and eccentricities. The vehicle may also become more sensitive to unbalance due to normal wear of moving parts.

WHEELS AND TIRES

Excessive wear in the center of the tread (Fig. 28) results from over-inflation, in which condition the fabric is more easily damaged.

Excessive wear at the outer edges of the tread (Fig. 29) results from under-inflation, a condition which causes excessive heating and premature tire failure.

**Wheel Changing Procedure (Pressed Steel Wheels)**

1. Place the vehicle on firm, level, ground if this is not possible exercise extreme caution.
2. Apply the handbrake.

3. Remove the spare wheel from below the luggage compartment floor (Fig. 31).
4. Check the spare wheel pressure and ensure that it is correct (i.e. Front 20 p.s.i. or Rear 24 p.s.i.).
5. With the tool provided slightly slacken the wheel nuts (Fig. 30).
6. Locate the head of the jack under a chassis member (rearward of the front wheel or forwards of the rear wheel [Fig. 32]). Assemble the handle into the jack and turn to lift the wheel clear of the ground.



Fig. 27



Fig. 28



Fig. 29

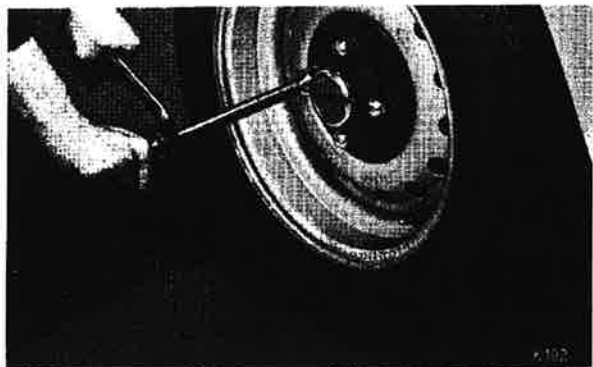

Fig. 30

7. Remove the wheel nuts and hub trim and lift off wheel.
8. Fit spare wheel and hub trim plate securing with wheel nuts. Ensure that the wheel nuts tighten without trapping the hub trim.
9. Lower wheel and remove jack.
10. Tighten wheel nuts securely and press hub trim (which should rock on its springs) to ensure that the wheel nuts are correctly positioned.
11. Stow tools and spare wheel in luggage compartment.

**Wire Spoke Wheels (Optional) (Figs. 33, 34)**

Before fitting a wheel, ensure that the following are undamaged, cleaned and coated with P.B.C. GREASE\* provided in the tool kit:

- (A) Adaptor taper and mating wheel hub taper
- (B) Splines
- (C) Wheel hub outer taper and large wheel nut taper

Slide the wheel on to the adaptor and pushing against the wheel hub center to maintain concentric location, simultaneously screw on the retaining nut by hand until the wheel is felt to seat on the adaptor taper.

Restraining the wheel with one hand, continue to tighten the wheel with a spanner. Grip tire at diametrically opposite areas of its circumference and attempt to rock the wheel on its adaptor. If free play (other than that due to hub bearing clearance) is apparent, release center lock nut and re-tighten whilst pushing wheel on to adaptor.

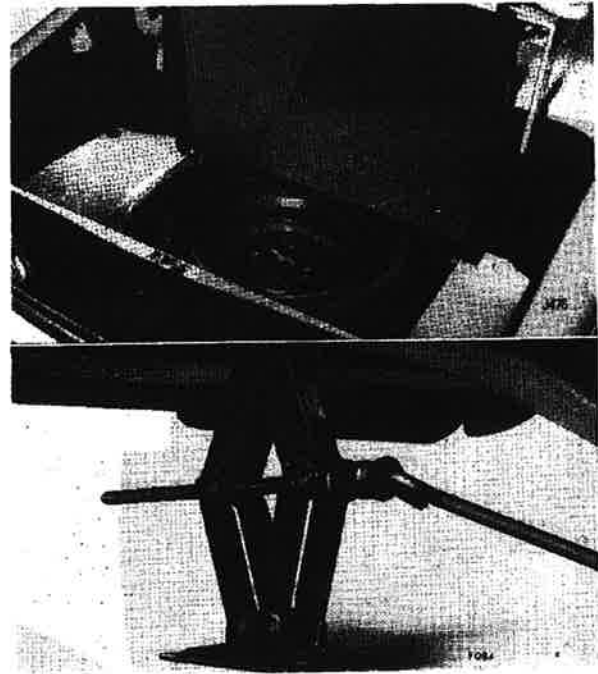

Fig. 31 (upper) Fig. 32 (lower)

WHEELS AND TIRES

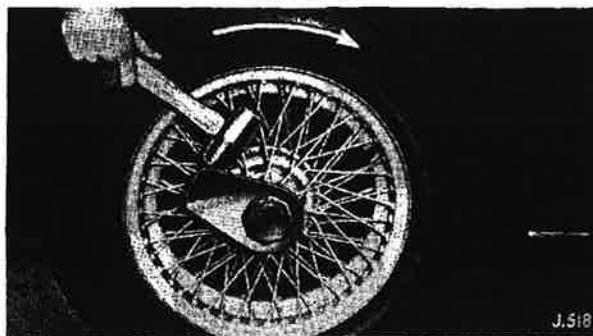
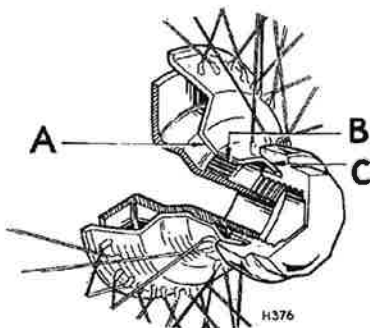

Fig. 33 (upper) Fig. 34 (lower)

Lower the wheel to the ground and finally tighten. Check that each wheel retaining nut tightens in the opposite direction to the wheel rotation. The foregoing instructions apply each time a wheel is removed and replaced.

**IMPORTANT:** Splined adaptors must be fitted to the correct side of the vehicle—left-hand threaded adaptors to the right-hand side and right-hand threaded adaptors to the left-hand side (as viewed from the driver's seat).

**NOTE:** Tubed Tires must be used with wire wheels.

\* P.B.C. GREASE is obtainable from TRIUMPH dealers in 4½ oz. tubes under Part Number 153317.

Minimum average spoke torque	Outer rim spokes		Inner rim spokes	
	lb.in.	kg.cm.	lb.in.	kg.cm.
	55	63.8	40	46.5

**Wheel Alignment**

The correct front and rear wheel alignment is 0° to ¼° (1.6 mm.) toe-in (curb condition). Excessive misalignment caused by curb impact or other accidental damage will result in severe tire wear and faulty steering.

**Wheel Run-out and Ovality**

The maximum tolerances for both run-out and ovality are as follows:

- Press steel wheels .. .. 0.070" (0.18 mm.)
- Wire spoke wheels .. .. 0.060" (0.15 mm.)

Excessive run-out and ovality will result in severe tire wear and faulty steering.

## COOLING SYSTEM

The pressurised "no less" cooling system incorporates a translucent plastic overflow reservoir (Fig. 39) which collects excess coolant from the radiator as the coolant in the system expands with heat. Depression created as the system cools, causes the coolant to flow back from the reservoir into the radiator. The fluid level, which is visible through the translucent reservoir, should be maintained at least half full when cold.

**Draining**

To drain the system, move the heat control (22) Fig. 2, to the hot position, remove the radiator filler cap (Fig. 36) and open the tap at the rear right-hand side of the cylinder block (Fig. 37) and the tap at the bottom of the radiator (Fig. 35).

**Note.** See "Caution", page 45.

**Flushing**

Efficient cooling is maintained by thoroughly flushing the system once each year before adding anti-freeze. When carrying this out, it is advantageous to remove the drain tap completely and to use plenty of clean running water.

Allowing anti-freeze solution to remain in the system throughout the summer period affords anti-corrosion protection. The solution, however, should be changed at the beginning of each winter period as the inhibitor becomes exhausted.

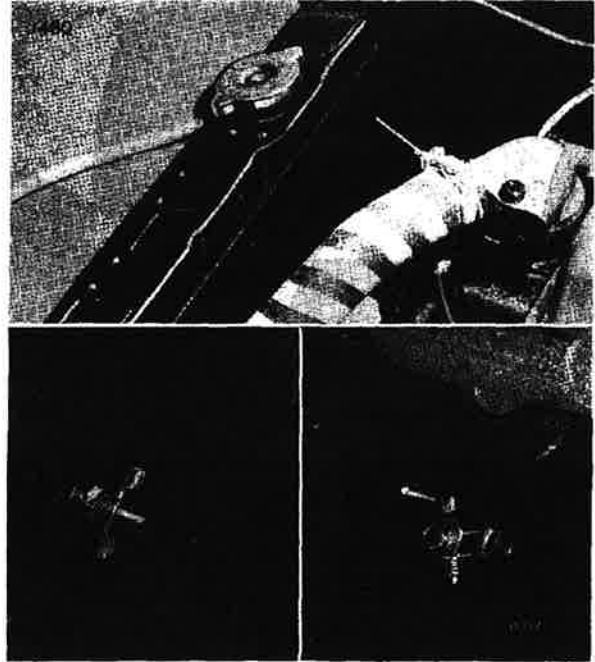

Fig. 35 (left) Fig. 36 (upper) Fig. 37 (right)

27

## COOLING SYSTEM

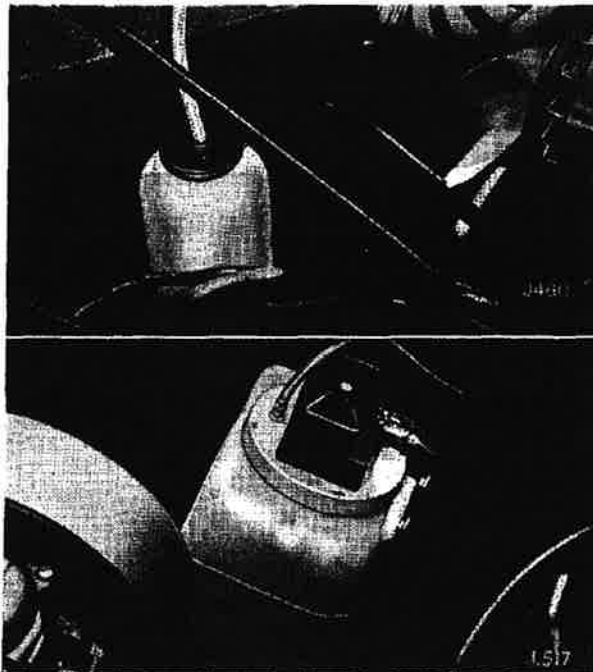

Fig. 38 (upper) Fig. 39 (lower)

28

**Filling**

Close both drain taps, open the heater control fully and remove the radiator filler cap. Fill the cooling system with clean (soft) water and run the engine at approximately 1,500 r.p.m. for 1 or 2 minutes. Top-up the radiator and replace the filler cap. Completely fill the plastic overflow reservoir with clean water.

**Windshield Washer (Fig. 39)**

Examine the water level in the plastic windshield washer container. If required, lift off the cap and replenish the container with clean water. Under freezing conditions, fill the container with a mixture of methylated spirits (alcohol) and water, the recommended proportions being 1 part alcohol to 2 parts water. This may then be used to disperse ice and snow from the windshield. Do not use anti-freeze solution in the windshield washer as this may discolor the paintwork and damage the wiper blades and sealing rubber.

**Frost Precautions**

The car heater cannot be completely drained by normal methods. Therefore frost damage will not be prevented by merely draining the radiator.

For your protection during freezing weather, an approved anti-freeze solution should be added to the coolant in the radiator.

Because of the searching effect of these solutions, advise your dealer to check the system for leaks before adding the anti-freeze.

At certain temperatures glycol water solutions adopt a "mushy" state with a viscosity which impairs circulation and can immobilise or damage the water pump. Therefore, consult the following chart before adding anti-freeze, for the degree of frost protection required.

ANTI-FREEZE CONCENTRATION .. .. .	25%	30%	35%
<i>Complete Protection</i> Vehicle may be driven away immediately from cold .. ..	10°F. (-12°C.)	3°F. (-16°C.)	-4°F. (-20°C.)
<i>Safe Limit</i> Coolant in mushy state. Engine may be started and vehicle driven away after short warm-up period	0°F. (-17°C.)	-8°F. (-22°C.)	-18°F. (-28°C.)
<i>Lower Protection Limit</i> Prevents frost damage to cylinder head, block and radiator .. Engine should NOT be started until thawed out	-14°F. (-26°C.)	-22°F. (-30°C.)	-28°F. (-33°C.)

**ELECTRICAL**

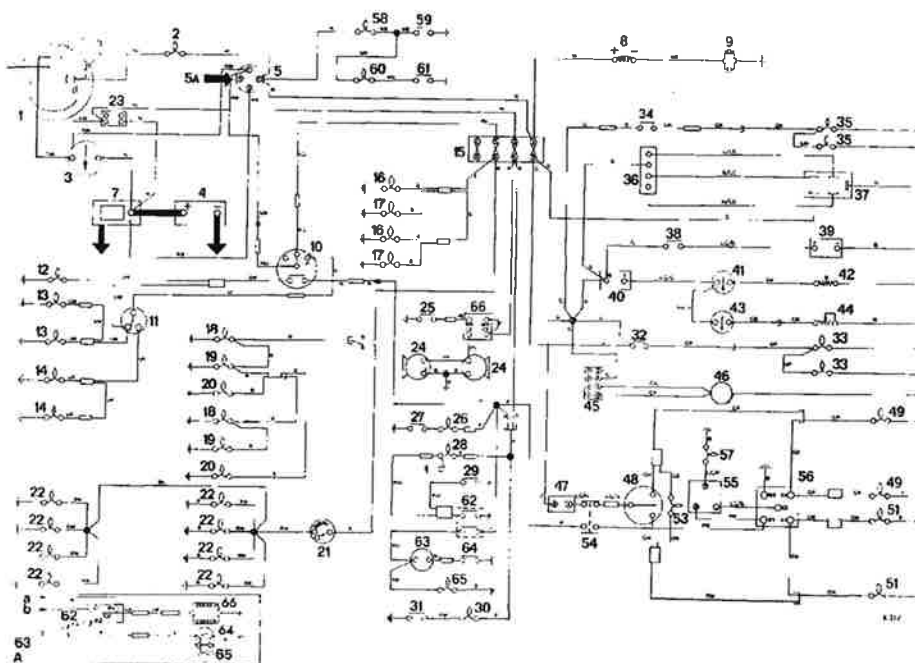

**Fig. 40 Wiring diagram**



## KEY TO WIRING DIAGRAM

**CAUTION:** THIS VEHICLE IS FITTED WITH A NEGATIVE EARTH ELECTRICAL SYSTEM. ENSURE THAT THE BATTERY EARTH LEAD IS ALWAYS CONNECTED TO THE BATTERY NEGATIVE TERMINAL.

THE ALTERNATOR—AND POSSIBLY SOME ACCESSORIES—CONTAIN POLARITY SENSITIVE COMPONENTS THAT MAY BE IRREPARABLY DAMAGED IF SUBJECTED TO INCORRECT POLARITY.

1 Alternator	25 Horn push	51 R.H. Flasher lamp
2 Ignition warning light	26 Cubby box illumination	53 Turn signal warning light
3 Ammeter	27 Cubby box illumination switch	54 Hazard switch
4 Battery	28 Transmission tunnel lamp	55 Hazard flasher unit
5 Ignition/starter switch	29 R.H. door switch	56 Hazard relay
5A Ignition/starter switch— radio supply connector	30 Luggage boot lamp	57 Hazard warning light
7 Starter motor	31 Luggage boot lamp switch	58 Brake line failure warning light
8 Ignition coil	32 Stop lamp switch	59 Brake line failure switch
9 Ignition distributor	33 Stop lamp	60 Oil pressure warning light
10 Column light switch	34 Reverse lamp switch	61 Oil pressure switch
11 Dip switch	35 Reverse lamp	62 L.H. door switch
12 Main beam warning light	36 Windscreen wiper switch	63 Key warning buzzer
13 Main beam	37 Windscreen wiper motor	64 Key switch
14 Dip beam	38 Windscreen washer switch	65 Courtesy light
15 Fuse box	39 Windscreen washer pump	66 Horn relay
16 Front parking lamp	40 Voltage stabilizer	
17 Front marker lamp	41 Heater indicator	
18 Rear marker lamp	42 Temperature transmitter	
19 Tail lamp	43 Fuel indicator	
20 Plate illumination lamp	44 Fuel tank unit	
21 Panel rheostat	45 Heater switch	
22 Instrument illumination	46 Heater motor	
23 Connector block	47 Turn signal flasher unit	
24 Horn	48 Turn signal switch	
	49 L.H. Flasher lamp	

## COLOUR CODE

N. Brown	LG. Light Green
U. Blue	W. White
R. Red	Y. Yellow
P. Purple	S. Slate
G. Green	B. Black

31

## ELECTRICAL

## FUSE SYSTEM

The fuse box is mounted on the left-hand side of the engine bay. The unit contains three operational fuses, one fuse available for use to protect an accessory circuit and has provision to house two spares. The fuses are protected by a pull-off cover.

Failure of a particular fuse is indicated when all the circuits protected by it become inoperative. If a new fuse fails establish the cause and rectify the fault before fitting a second replacement.

Fuse	Manufacturer . . . . .	Lucas
Rating . . . . .	.. .. .	35 amp.
Lucas Part No. . . . .	.. .. .	188218
Stanpart No. . . . .	.. .. .	58465

## Circuits

The top fuse is not used on a standard production vehicle.

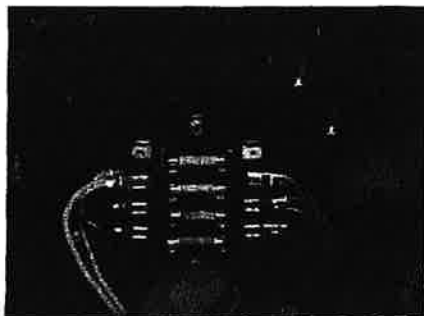

Fig. 41

32

It may be employed in service to protect an accessory circuit.

The fuse fed by a white cable from the ignition/starter switch protects the following circuits:

- Stop lamp
- Reverse lamp
- Windscreen wiper
- Windscreen washer
- Temperature indication
- Fuel indication
- Heater
- Turn signal

The fuse fed by a brown cable from the battery protects the following circuits:

- Horn
- Headlamp flasher
- Cubby box illumination
- Key warning
- Courtesy light
- Hazard warning
- Transmission tunnel lamp
- Luggage boot lamp

The fuse fed by a red/green cable from the column light switch protects the following circuits:

- Front parking lamp
- Front marker lamp
- Rear marker lamp
- Tail lamp
- Plate illumination lamp
- Instrument illumination

## CHARGING SYSTEM

**CAUTION: THE ALTERNATOR CONTAINS POLARITY SENSITIVE COMPONENTS. REFER TO "CAUTION" ON PAGE 31.**

DO NOT MAKE OR BREAK ANY CONNECTIONS IN THE CHARGING CIRCUIT—INCLUDING THE BATTERY LEADS—WHILE THE ENGINE IS RUNNING OR DAMAGE TO COMPONENTS MAY OCCUR. THE ALTERNATOR MUST ONLY BE RUN WITH ALL THE CHARGING CIRCUIT CONNECTIONS MADE OR WITH THE ALTERNATOR MULTI-SOCKET CONNECTORS DISCONNECTED.

HIGH VOLTAGES MAY DAMAGE SEMI-CONDUCTOR DEVICES. REMOVE ALTERNATOR MULTI-SOCKET CONNECTORS BEFORE PERFORMING ANY ELECTRIC ARC WELDING ON THE VEHICLE.

**Alternator**

The Lucas 15ACR alternator—which contains its own control unit—is driven by a vee belt which should be adjusted as detailed on page 53. The field winding rotor runs on two "lubricated for life" ball bearings. (No routine lubrication is required).

**Ignition Warning Light**

The three "field winding supply" diodes enable a circuit similar to a conventional generator warning light circuit to be employed. If the warning light remains illuminated during normal running a fault is indicated.

## BATTERY

**CAUTION: REFER TO "CAUTIONS" ON PAGES 31 AND 33.**

A conventional battery is located on the bulkhead. Battery data is given on page 67.

Ensure that the battery top and terminals remain clean and dry. Coat terminals with petroleum jelly (Vaseline) to prevent corrosion.

Check electrolyte level monthly and if required replenish with pure water as detailed on page 46. If electrolyte has been spilled clean the affected area with a cloth moistened with ammonia to neutralize the acid and prevent acid corrosion.

Ensure that the battery is always firmly clamped in position by the retaining assembly. When fitting battery leads do not hammer terminals to terminal posts. Such action may damage battery.

The battery will deteriorate rapidly if left in a discharged condition. If the unit is reduced to a low state of charge it should be recharged at the first opportunity.

33

## ELECTRICAL

## BULB CHART

Light	Watts	Lucas Part No.	Stanpart No.	
<b>Headlights</b>				
R.H. Dip—U.S.A. .. .. .	50/40	54522231	—	*
France .. .. .	45/40	411	510219	
Other R.H. Dip markets ..	45/40	410	510218	
L.H. Dip .. .. .	60/45	54521872	512231	*
Front parking and flasher lamps	5/21	380	502287	
Front marker lamps .. .. .	4	222	501436	
Rear marker lamps .. .. .	4	222	501436	
Rear flasher lamps .. .. .	21	382	502379	
Tail/stop lamps .. .. .	5/21	380	502287	
Reverse lamps .. .. .	21	382	502379	
Plate illumination lamps .. ..	6	207	57591	
Luggage boot lamp .. .. .	3	256	57599	
Transmission tunnel lamp .. ..	6	254	59897	
Courtesy light .. .. .	2·2	987	59492	
Cubby box illumination .. .. .	2·2	987	59492	
Instrument illumination .. .. .	2·2	987	59492	
Warning lights .. .. .	2·2	987	59492	

34

## HEADLAMPS

**NOTE: TO AVOID BEAM AIMING DO NOT DISTURB BEAM AIMING SCREWS A AND B.**

**Beam Aiming**

Insert a large screwdriver behind rim adjacent to clip as shown on Fig. 42. Twist screwdriver to release rim from clip. Lift rim from upper retainers. Screw A positions the beam in the horizontal plane. Screw B controls beam height.



Fig. 42

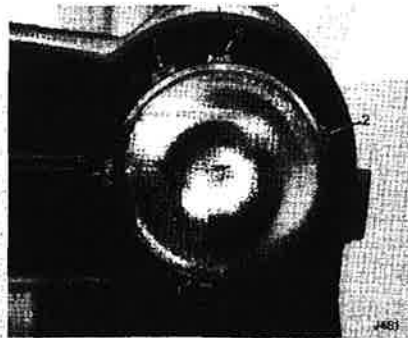

Fig. 43

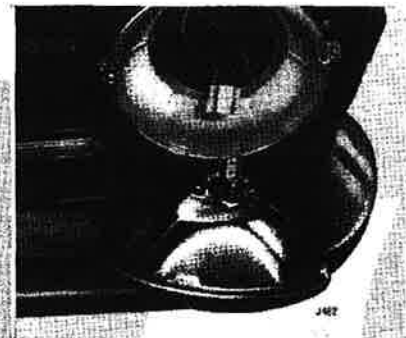

Fig. 44

35

Beam aiming can best be accomplished using equipment such as Lucas "Beamsetter" or "Lev-L-Lite". This service is available at Triumph distributors or dealers and will ensure maximum road illumination with minimum discomfort to other road users.

**Filament Failure**

In the event of a filament failure the sealed beam light unit must be replaced. Insert a large screwdriver behind rim adjacent to clip as shown on Fig. 42. Twist screwdriver to release rim from clip. Lift rim from upper retainers. Remove three screws 1, 2 and 3 to release retaining rim and sealed beam light unit. Pull connector from light unit. Renew light unit and reassemble.

## ELECTRICAL

## LAMPS—BULB RENEWAL

Bulb renewal for the majority of lamps is conventional. Remove lens by unscrewing required screw/screws. Renew bulb and re-assemble.

**Rear marker, rear flasher, tail/stop and reverse lamps**

Open luggage boot lid. Remove carpet. Remove spare wheel cover. Remove six screws and withdraw appropriate trim panel. Pull appropriate bulb holder from lamp base. Renew bulb and reassemble.

**Luggage Boot Lamp**

Open luggage boot lid. Detach lens and base by removing two screws. Renew festoon bulb and reassemble.

36

**Transmission Tunnel Lamp**

Remove lens by unscrewing two screws. Carefully renew festoon bulb and reassemble.

**Cubby Box Illumination**

Open cubby box lid. Carefully unscrew bulb from holder. Renew bulb.

**Instrument Illumination**

Pull bulb holder—which is a component of the main harness—from instrument. Unscrew bulb from holder. Renew bulb and reassemble. Note speedometer and tachometer each contain two illumination bulbs.

**Warning Lights**

Pull bulb holder—which is a component of the main harness—from instrument or housing. Unscrew bulb from holder. Renew bulb and reassemble.

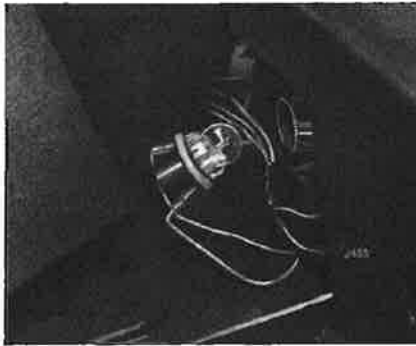

Fig. 45

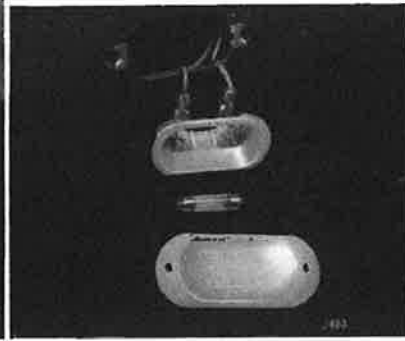

Fig. 46



Fig. 47



Fig. 48

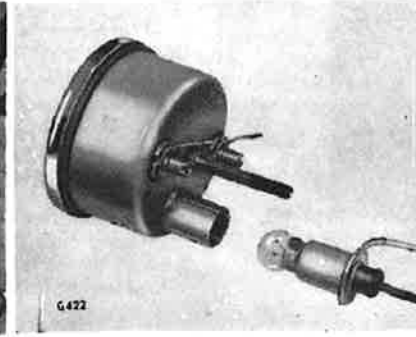

Fig. 49

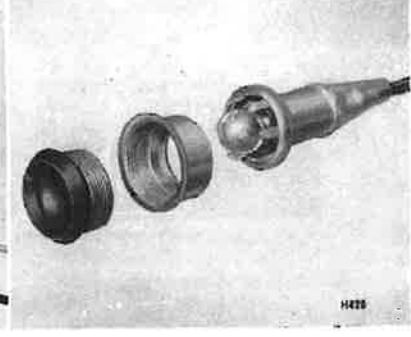

Fig. 50

37

## ELECTRICAL

## TURN SIGNAL FLASHER UNIT—RENEWAL

Locate unit attached to clip secured to bulkhead end panel adjacent to passengers feet. Pull unit from clip. Disconnect electrical connectors. Connect electrical connectors to new unit and insert into clip.



Fig. 51

38

## KEY WARNING SYSTEM

This system is designed to encourage the driver to remove the ignition key from the lock before leaving the vehicle. The system should prevent encouragement of theft but is not intended as a comprehensive anti-theft device.

If the driver's door is opened while the ignition key is in the lock an audible buzzer will sound. Removing the key or closing the door will cause the buzzing to cease.

The buzzer is housed in a cylindrical container located adjacent to the courtesy light.

Associated with the key warning system is the courtesy light which illuminates the lock to facilitate key entry and the transmission tunnel lamp. The left-hand door switch contains two individual contact sets. One set controls the supply to the buzzer and courtesy light while the second set provides an earth return for the transmission tunnel lamp circuit. The single function right-hand door switch provides an earth return for the transmission tunnel lamp circuit. Refer to wiring diagram for full circuit information.

## DRIVING RECOMMENDATIONS

### Starting the Engine from Cold

Check, and if necessary top up, the radiator water level and the engine oil level. If the car has not been used for several days and fuel has evaporated from the carburetors, refill them by operating the priming lever on the fuel pump. The slight resistance ceases when the float chambers are full.

Apply the handbrake and ensure that the gear shift lever is in the "Neutral" position. In cold weather pull the "cold start" control fully out; in warm weather pull to the mid-position. In hot climates, do not use the control. Insert the ignition key and turn it to the "Ignition" position, causing the "no charge", "low oil pressure" and "brake failure" indicator lights to glow, the fuel gauge to register the contents of the fuel tank and the temperature gauge to register the temperature of the engine coolant.

From the "Ignition" position, turn the key clockwise against spring pressure to operate the starter motor. Immediately the engine fires, release the key, which will return to the "Ignition" position. Should the engine fail to start at the first attempt, do not re-operate the starter switch until the starter motor has come to rest.

As soon as the engine starts, push the cold start control "half in" (cold climates), or "fully in" (warm climates) and warm the engine at an idling speed of approximately 1,500 r.p.m. This will

cause the "no charge", "low oil pressure" and "brake failure" indicator lights to be extinguished, thus indicating satisfactory performance of the generating, lubricating and braking systems. Should an indicator light remain on, stop the engine and establish the cause. Failure to do so may result in serious damage.

After starting the engine, cylinder wear is minimised if the engine is warmed up quickly by driving away when the indicator lights are extinguished. Maintain an engine speed of approximately 1,500 r.p.m. until the "cold start control" can be pushed fully in. In warm climates, use of the control may be unnecessary. Avoid the use of full throttle during the warming-up period. A thermostat incorporated in the cooling system enables the engine to be warmed up quickly from cold.

### Starting a Hot Engine

When re-starting a hot engine, depress the throttle pedal to about one-third of its travel before operating the starter switch. The cold start control should not be used.

### Running-in

The importance of correct running-in cannot be too strongly emphasised, for during the first few thousand miles of motoring, the working surfaces of a new engine are bedding down.

39

## DRIVING RECOMMENDATIONS

When driving from new, avoid placing heavy loads upon the engine, such as using full throttle at low speeds or when the engine is cold. Running-in should be progressive, and no harm will result from the engine being allowed to "rev" fairly fast for short periods provided that it is thoroughly warm and not pulling hard. Always select a lower gear if necessary to relieve the engine of load.

Full power should not be used until at least 1,000 miles (1,600 km.) have been covered and even then, it should be used only for short periods at a time. These periods can be extended as the engine becomes more responsive.

### Recommended Speed Limits

Owners are advised not to drive the car at engine speeds over 5,500 r.p.m., indicated by the beginning of the red segment on the tachometer, and to avoid over-revving, particularly in the lower gears.

### Recommended Fuel

The "TR6" engine is designed to operate on fuels having a minimum octane rating of 100 (Research Method).

### Overdrive Unit (when fitted)

An overdrive unit serves as a convenient method of providing, at will, a numerically lower overall gear ratio to reduce engine speed and wear, and to effect fuel economy.

Greatest benefit will accrue from judicious use of the overdrive, the governing factor being that the vehicle continues to run easily without sign of engine laboring, combined with the minimum amount of throttle opening necessary to maintain this condition.

Do not change from overdrive at engine speeds in excess of 4,000 r.p.m. This corresponds approximately with peak revs. in normal gears. Damage can result from overdrive disengagement at higher engine speed.

## ROUTINE SERVICING

The lubricants listed on page 63, have maintained a high standard of quality over many years and are approved only after extensive tests in collaboration with the oil companies concerned. In countries where these oils are unobtainable, use similar oils having the same characteristics. The use of only high grade lubricants is vitally important and cannot be over-emphasised.

**Engine**

When a new car is delivered, the engine oil pan contains a quantity of special oil, sufficient for the running-in period. Should the level fall below the low mark on the dipstick, the oil pan may be topped-up with any of the approved lubricants.

At the "Free Service", the running-in oil is drained and the oil pan replenished to the level of the high mark on the dipstick, with one of the approved oils.

**Transmission, Overdrive and Rear Axle**

Rear axles, transmission and overdrive units fitted to new cars are filled with a special oil, formulated to give all necessary protection to new gears. This oil should not be drained but may be topped up with any of the approved oils.

**Braking System**

In addition to adjustment and examination/renewal of shoes and pads at the intervals recommended in the following pages, it is strongly recommended that the brake fluid be renewed and

that the braking system be overhauled every 36,000 miles (60,000 km.) or 3 years (whichever is the sooner).

Overhauling the brake system involves dismantling, examining and renewal of all seals and defective items.

Owners are urged to seek the assistance of any Triumph Distributor or Dealer who will be pleased to estimate for the work which is of such a nature that it should be entrusted only to skilled workshop personnel.

**Preventive Maintenance**

To ensure continued efficiency and prolonged vehicle life, the maintenance voucher scheme, produced by Standard-Triumph engineers, offers a carefully designed plan of lubrication requirements and adjustment checks at pre-determined periods.

Operated by all Triumph dealers, and specifically recommended to owners wishing to obtain the greatest pleasure from their motoring, the scheme involves the use of a series of Maintenance Vouchers contained in a booklet supplied with the car. Service operations appropriate to mileage or periods of time are listed on pages preceding the vouchers.

The space provided on the counterfoil of each voucher should be filled in by the dealer to constitute proof of regular servicing, should this be required when making a claim under the warranty, or when selling the vehicle.

41

## EMISSION AND EVAPORATIVE CONTROL SYSTEM

Every Triumph TR6 1970 model year entering the American Market incorporates an efficient Emission and Evaporation control system which is designed and built in accordance with stringent Federal Regulations for 1970 model year cars governing the emissions from the crankcase and exhaust. This vehicle is also in compliance with the Federal Regulations for 1971 model year cars governing the loss by evaporation of fuel from the vehicles fuel delivery system.

The system is designed to work within the following requirements:—

<b>Emission</b>	2.2 grammes per mile Hydrocarbons 23 grammes per mile Carbon monoxide
<b>Evaporation</b>	Maximum fuel loss through evaporation is 6 grammes per test. The test is as defined by the Federal Authorities.

**EMISSION CONTROL SYSTEM—SERVICING**

The importance of servicing at the correct intervals cannot be overstressed as improvements in design and manufacturing techniques count for nothing if the servicing standards are not upheld.

Routine servicing, carried out at the mileage intervals quoted will prevent any deterioration to the system. In addition to normal lubrication and nut tightness checks, those items which should receive attention during routine servicing include: distributor maintenance (page 52), carburettor dash-pot oil replenishment (page 53) and slow running adjustment, spark plugs (page 51), valve rocker clearances (page 50), air cleaner (49), crankcase ventilation (page 52) and fuel filter (page 52).

Ignition Distributor, refer to page 66 for ignition timing.

**1,000 Mile Free-Service**

In addition to the operations listed on page 47, check to

ensure that the correct ignition timing is maintained at engine idling speed. Repeat this check every 6,000 miles.

**EVAPORATION CONTROL SYSTEM—SERVICING**

Minimal servicing is required on the evaporation control system apart from changing the filter gauze, in the carbon canister every 12,000 miles (20,000 km) and replacing the canister every 48,000 miles (80,000 km). See page 52.

**CARBURETTOR**

The twin Stromberg CD.5E 175 emission carburettors are the prime components of the emission system and great care is exercised during the manufacture and initial adjustment of these instruments. Because of the precise manufacturing limits involved and the assembly methods adopted to prevent unauthorised tampering during use, the extent of permissible servicing is restricted to the following:

**Adjustments (Fig. 43)**

There are only three adjustments that can be made to emission carburettors in the field and these are:

- 1. Idling speed:** Ensure that the fast idle screw (1) (Fig. 52) is clear of the cam (2) and the choke lever is against its stop with the facia control pushed fully in. Unscrew the idling screw (3) until the throttle is just closed. Turn the screw  $1\frac{1}{2}$  turns to provide a datum setting.  
Start the engine and attain normal running temperature before final adjustment of the idling screw achieves a constant 800 to 850 r.p.m.
- 2. Fast Idling:** Ensure that the choke lever is fully returned and the facia control knob pushed in. Set the gap "A", between the fast idle screw (1) and the cam (2), at .035 in. Start the

42

engine and while it is still cold (68-86F) pull the facia control fully out to check the fast idle speed and, if necessary, adjust to 1,100 r.p.m. with the screw. Tighten the locknut and re-check the fast idling speed.

3. **Idle emission:** An idle trimming screw (4) is provided to give very fine adjustment to compensate for the difference between a new "stiff" engine and one that is "run in", THIS IS NOT AN ORDINARY MIXTURE ADJUSTING SCREW; it regulates a limited amount of air that can be introduced into the mixing chamber. It is important to remember that the ear will not detect any difference between the fully "home" and fully "open" position of the screw. The setting should therefore, be checked by means of a C.O. meter or an air/fuel ratio meter to the exhaust pipe. (The correct C.O. level is  $1\frac{1}{2}\%$ - $2\frac{1}{2}\%$  and air/fuel ratio is 14.4 : 1-13.6 : 1.

**Carburettor Controls**

The throttle rod linkage will not require adjustments during normal operation. To ensure complete throttle closure a degree of "lost motion" or slackness is incorporated into the linkage, no attempt must be made to adjust this out "B", Fig. 52.

Occasionally lubricate the linkage and choke cable with thin oil.

**Carburettor Servicing Schedules**

To maintain the carburettor at peak efficiency, regular servicing at 6,000 miles intervals is essential. This also involves the use of coloured gaskets which give indication that the 24,000 mile service has been carried out. The appropriate servicing operations should be performed by authorised dealers who are trained in the use of the special equipment needed.

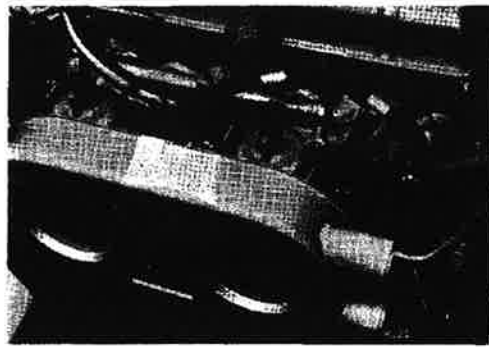
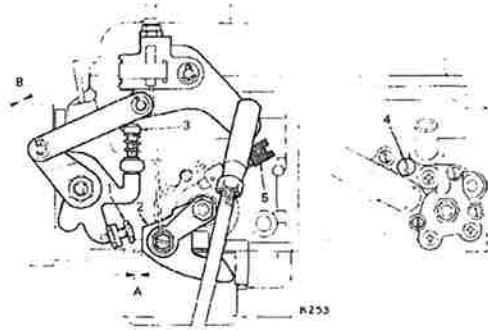

Fig. 52 (upper)

Fig. 53 (lower)

EMISSION AND EVAPORATIVE CONTROL SYSTEM

1. Flame trap Filter
2. Pipe-Canister purge
3. Activated Carbon Canister
4. Pipe-overflow tank to Canister
5. Overflow Tank
6. Main Fuel Tank
7. Sealed Filler Cap
8. Pipe Filler to Overflow Tank

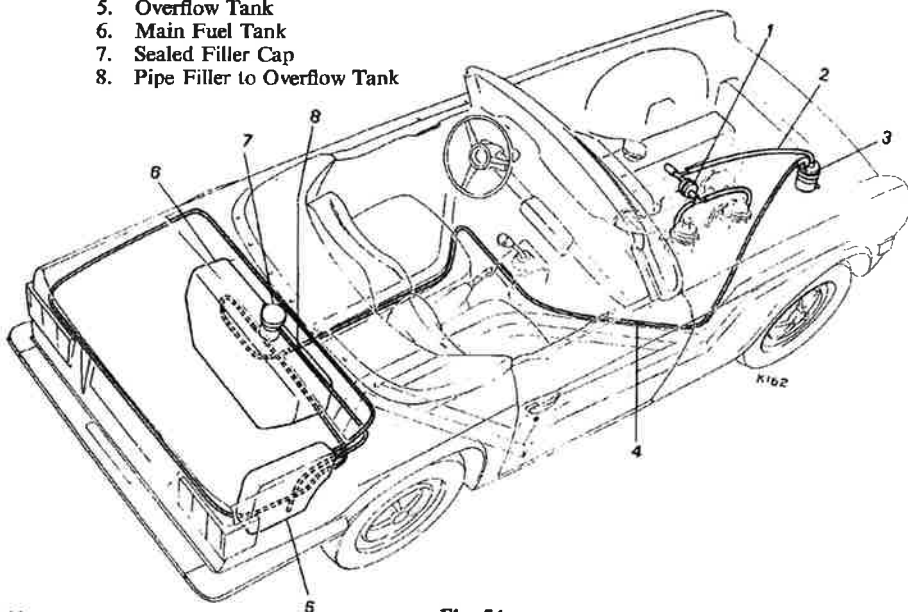
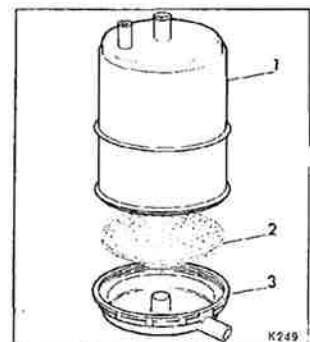

Fig. 54



1. Carbon Canister
2. Filter Gauze
3. Base Cap

Fig. 55

**Engine—Daily**

Prior to starting out on a long run, or every 250 miles (400 km.), check the engine oil level and, if necessary, add oil until the level reaches the high mark on the dipstick.

Before checking the level, make sure that the car is standing on level ground. The dipstick, located on the left-hand side of the crankcase (Fig. 56) may then be withdrawn, wiped clean and pushed fully home before withdrawing it for reading. Should the level be at the lower mark on the dipstick, 2.4 pints (U.S.A.) (1.14 litres) will be required for topping up via the cap (Fig. 57).

**Brake Master Cylinder (1, Fig. 58)**

Every week check the level of fluid in the brake master cylinder reservoir. The fluid level is visible through the translucent casing of the reservoir, do not remove the cap. A gradual lowering of the level over a long period is caused by brake pad wear and does not require topping-up. A sudden appreciable drop in the level must be investigated, the cause ascertained and rectified immediately.

Do not allow the level to drop below the danger line on the side of the casing.

To avoid dirt entering the system ensure that the reservoir is clean externally before removing the cap. Use only new fluid taken from a sealed container and re-seal the container after use. Replace the reservoir cap immediately after filling.

**Radiator Water Level—Weekly (Fig. 38)**

The level of water, visible through the translucent plastic reservoir mounted forward of the radiator, should be maintained at least "half-full" by adding soft water, when required, via the screwed cap.

Should the reservoir be allowed to empty, remove the radiator filler cap, completely fill the radiator, as described on page 28.

**CAUTION:** If the engine is hot, avoid danger from scalding by exercising extreme care when removing the radiator filler cap. Turn it a half-turn and allow pressure to be fully released before completely removing the cap.

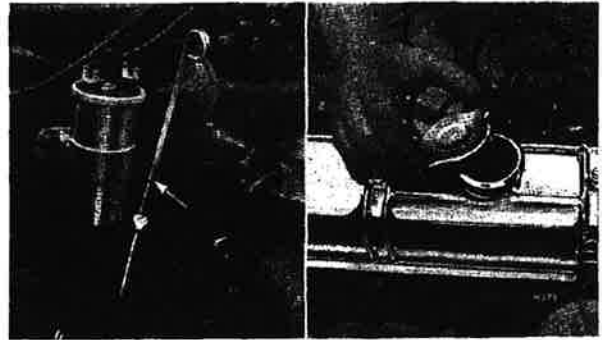

Fig. 56

Fig. 57

PERIODIC CHECKS

**Tires**

The maintenance of correct tire pressures is an important factor governing tire life, steering behaviour, braking, and riding comfort. It is, therefore, important that tire pressures are checked regularly at periods not exceeding two weeks, and the losses, due to diffusion, are made good. Correct tire pressures are given on page 23.

Adjust the pressures whilst the tires are cold, i.e. before a run. As the tires warm up their pressures increase. A warm tire bled to the recommended pressure will be under-inflated when cold.

**Windshield Washer**

Examine the water level in the plastic windshield washer container. If required, unscrew the cap and replenish the container with clean water. (Refer to page 28).

**Battery—monthly**

Examine the level of the electrolyte in the cells and, if necessary, add distilled water via the filler orifices to bring the level up to the top of the separators.

**CAUTION:** Never use a naked light when examining the battery. The mixture of oxygen and hydrogen given off by the battery is dangerously explosive.

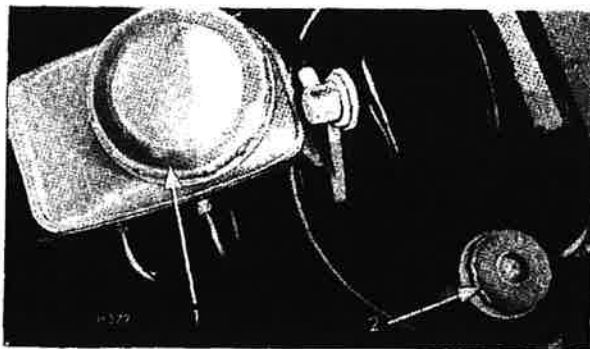

Fig. 58

**Clutch Master Cylinder (2, Fig. 58).**

Every month, check the level of fluid in the clutch master cylinder. To prevent dirt entering the system, clean the cap and surrounding area prior to removing the cap. Top-up the fluid until it is level with the line on the side of the reservoir.



1,000 MILES—FREE SERVICE

The engine oil pan is initially filled at the factory with a special running-in oil which should be drained after completing the first 1,000 miles (1,600 km.) and refilled with one of the high grade oils recommended. During this period many of the components, including the brakes, fan belt, gaskets, studs and nuts, settle down, thus necessitating slight adjustment and an overall check.

The owner is, therefore, urged at the completion of this period to return the vehicle to the selling dealer who will perform the following operations free-of-charge, except for oil and grease.

**ENGINE**

- Coolant—Check level
- Oil pan—Drain and refill
- Throttle control linkage and pedal fulcrum—Oil
- Mounting bolts—Check tightness
- Cylinder head—Check tightness
- Manifold—Check tightness
- Valves—Adjust rocker clearances
- Fan belt—Adjust tension
- Oil filter—Check for oil leaks
- Fuel pump—Clean filter
- Distributor—Lubricate. Adjust points and ignition timing at idling speed
- Carburetor—Top-up dampers and adjust idle controls

**TRANSMISSION**

- Transmission, Overdrive—Check level and top-up
- Rear axle—Check level and top-up

- Universal joint coupling bolts—Check tightness
- Rear drive shafts—Grease

**STEERING AND SUSPENSION**

- Front wheel alignment—Check with aid of tracking equipment
- Rear wheel alignment—Check by condition of tire tread
- Steering unit attachments and "U" bolts—Check for tightness
- Tie rods and levers—Check for tightness
- Lower steering swivels—Oil
- Upper ball joints—Grease

**BRAKES AND CONTROLS**

- Parking brake cable and linkage—Lubricate
- Hydraulic pipes—Check for leaks, chafing and for hose clearance
- Master cylinder—Check level and top-up
- Brake shoes and handbrake cable—Adjust as necessary

**WHEELS**

- Wheel nuts or wire wheel extension nuts—Check tightness
- Tires—Check and adjust pressures

**ELECTRICAL EQUIPMENT**

- Battery—Check and adjust electrolyte level. Check charging rate
- Alternator and starter motor—Check fixing bolts for tightness
- Headlights—Check alignment and adjust if required
- Lights, heater, windshield washer, wipers and warning equipment—Check operation

**BODY**

- Door strikers, locks and hinges—Oil and check operation
- Body mounting bolts—Check tightness
- Door handles, controls and windshield—Wipe clean

REGULAR MAINTENANCE

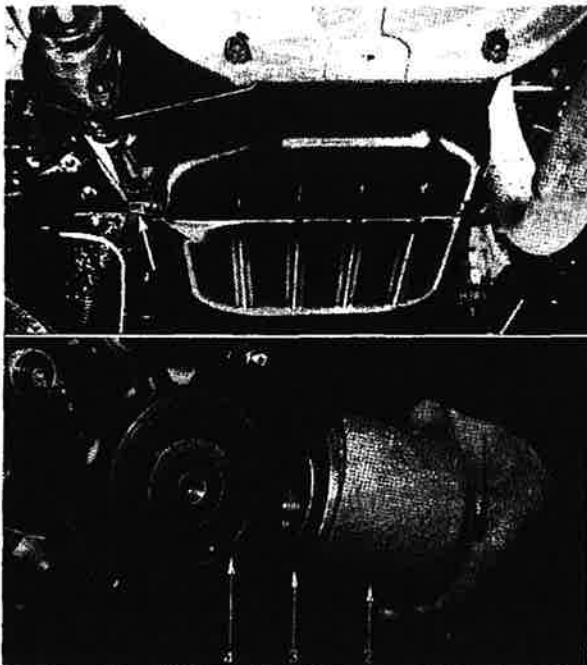

Fig. 59 (upper) Fig. 60 (lower)

**Engine Oil Pan (Fig. 59)**

Every 6,000 miles (10,000 km.), remove the plug (arrowed), to drain the oil. Refit the plug and refill to the correct level, via the filler cap, Fig. 45. Reduce this period according to the severity of the following unfavourable conditions.

1. Dusty roads.
2. Short journeys involving frequent stop/start driving, particularly during cold weather when greater use is made of the choke control.

If the vehicle is used for competition or sustained high speed work, the use of higher viscosity oil is recommended because of increased oil temperature.

**Oil Filter Element (Fig. 60)**

Every 12,000 miles (20,000 km.), unscrew the securing bolt (1), remove the container (2) and discard the element (3). Wash out the container and insert a new element.

Renew the sealing ring (4), ensuring that it is correctly located in the cylinder block and re-attach the filter assembly by tightening the bolt (1) sufficiently to ensure an oil-tight joint.

**Air Cleaner (Figs. 60 and 61)**

Every 6,000 miles (10,000 km.), or more frequently where conditions of extreme dust prevail, release the flexible hose (1) (early models only) from the plate (2). Unscrew six bolts (3) securing the container to the carburetor flanges, take off the cover plate (2) and lift out the elements (4), noting the positions of the rubber ring seals (5).

Clean out the container (6) and use a high pressure air line, or foot pump, to remove dust from between the folds of the paper element (4).

Re-assemble the air cleaner, ensuring that the slot (7) in the cover plate (2) and gasket (8) and the vent and bolt holes, align with those in the carburetor flanges.

Every 12,000 miles (20,000 km.), renew the paper elements.

**Compression Checks**

Every 6,000 miles (10,000 km.) have the compression pressures checked by your Triumph Dealer. Providing that the engine is functioning satisfactorily, and the compression pressures of all the cylinders are equal, you are advised not to disturb the engine.

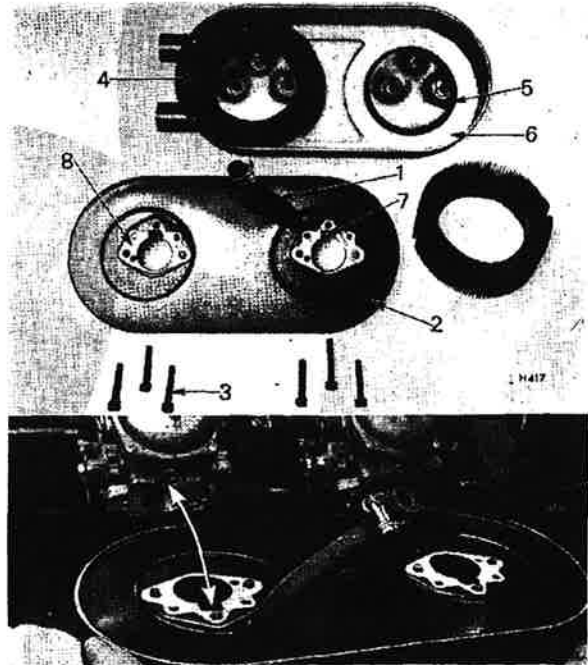

Fig. 61 (upper) Fig. 62 (lower)

REGULAR MAINTENANCE

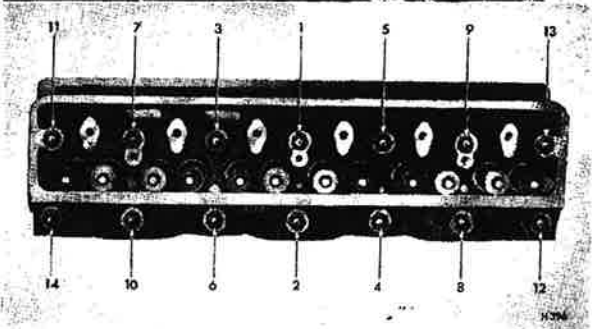
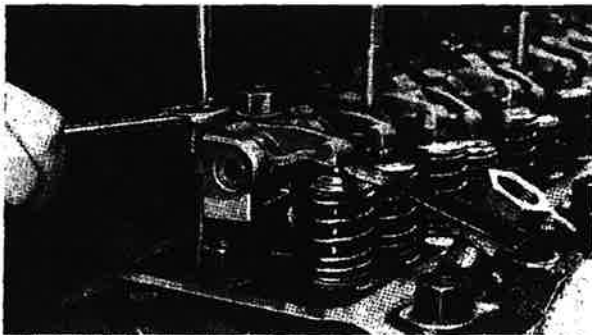

Fig. 63 (upper) Fig. 64 (lower)

The need for decarbonising arises when the build-up of carbon, a product of combustion, becomes excessive. If premium grade fuels and high quality lubricants are used, carbon deposit is so minimised that frequent decarbonising is unnecessary. Carbon removal may, therefore, be restricted to occasions when the cylinder head is removed for attention to the valves and seats.

**Valve Clearances—Adjustment (Fig. 63)**

Every 12,000 miles (20,000 km.), remove the rocker cover and, turning the engine clockwise, check and adjust the valve clearances to 0.010" (0.25 mm.) if required, in the following sequence while the engine is cold:

- Adjust Nos. 1 and 3 valves with Nos. 10 and 12 valves open
- " " 8 and 11 " " " 2 and 5 " "
- " " 4 and 6 " " " 7 and 9 " "
- " " 10 and 12 " " " 1 and 3 " "
- " " 2 and 5 " " " 8 and 11 " "
- " " 7 and 9 " " " 4 and 6 " "

Refit the rocker cover.

**Cylinder Head Nuts (Fig. 64)**

When required, tighten the cylinder head nuts in the order shown. Slacken them by reversing the sequence.

**Fuel Pump (Fig. 67)**

Every 12,000 miles (20,000 km.). Access to the petrol pump bowl and filter is gained by unscrewing the bolt (1) and removing the domed cover (2). Lift the filter gauze (3) from its seating and wash it in petrol.

Using a small screwdriver, loosen the sediment in the bowl and blow it clear by using a jet of compressed air. A foot pump used for tyre inflation is ideal for this purpose.

Renew the cork gasket if it has hardened or is broken. Assemble the filter gauze (3) into its seating, taking care to place the gauze face downwards so that it can be removed easily when required.

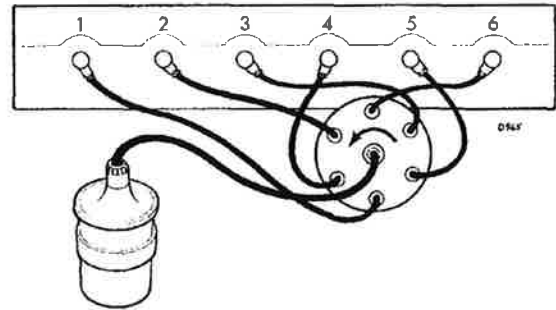

**Sparkling Plugs**

Every 6,000 miles (10,000 km.) remove sparking plugs for cleaning and reset the gaps to 0.25" (0.63 mm.). Clean the ceramic insulators and examine them for cracks or other damage likely to cause "H.T." tracking. Test the plugs and renew those which are suspect.

Every 12,000 miles (20,000 km.) renew all the sparking plugs. Ensure that they are of the correct type (page 66) and that the gaps are set to 0.25" (0.63 mm.).

Replace plug leads in the order shown in Fig. 66, i.e. firing order 1, 3, 3, 6, 2, 4.

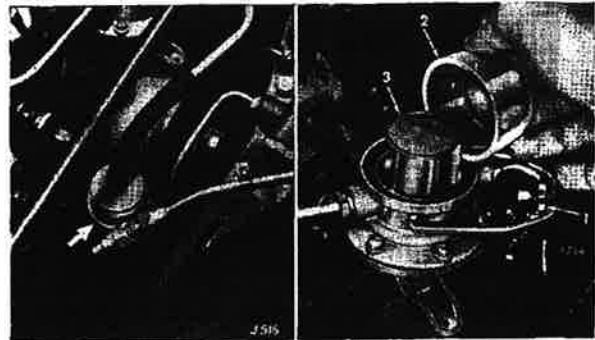

Fig. 65 (left)

Fig. 66 (upper)

Fig. 67 (right)

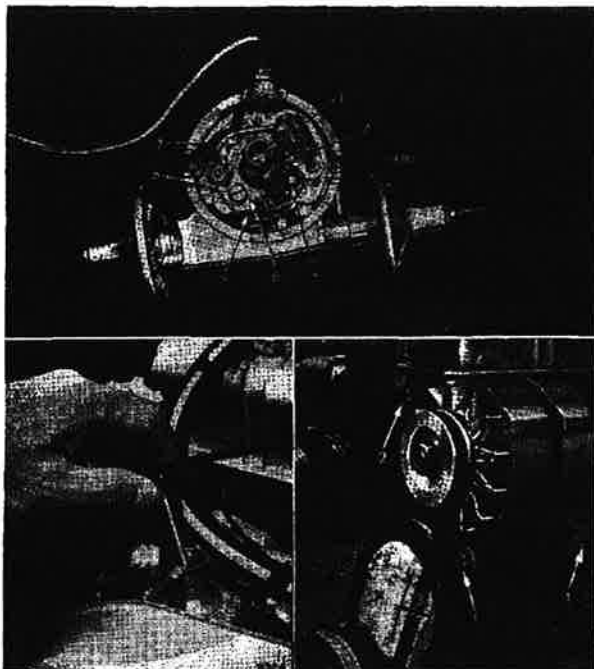

Fig. 68 (left)

Fig. 69 (upper)

Fig. 70 (right)

**Fuel Filter (Fig. 65)**

Every 6,000 miles (10,000 km.) renew the filter, ensure that the new filter is fitted according to the direction of flow as stated on the filter casing.

**Evaporation System—Carbon Canister (Fig. 55)**

Every 12,000 miles (20,000 km.) replace the filter in the carbon canister as follows:

Remove the inlet and purge tubes from the top of the canister (1). Slacken the clip securing the canister to its mounting bracket and remove the canister.

Unscrew the base cover (3) and remove the filter gauze (2). Clean the base cover, fit a new gauze, replace cover and refit the canister.

Ensure that all piping is not chaffing and free from kinks.

Every 48,000 miles replace the canister adopting the method described above.

**Engine Breather Pipes (Fig. 53)**

Every 12,000 miles (20,000 km.) remove and clean the piping connecting the rocker cover to the carburettors and the carbon canister. Clean breather oil filter or rocker cover filter in clean fuel.

**Ignition Distributor (Fig. 69)**

Every 6,000 miles (10,000 km.) release the clips and remove the distributor cap and rotor arm. Smear the cam (5) lightly with oil and apply a few drops of thin oil to the screw (4), in the center of the cam, and a single drop on the contact breaker pivot (6).

Turn the engine until the contact breaker lever is operating on the highest point of the cam lobe, i.e. gap at its widest. Slacken the fixed contact screw (2), insert a screwdriver into the "Vee"-shaped cut-out in the contact lever (1) and adjust the lever to obtain 0.015" (0.4 mm.) gap using a feeler gauge between the contacts (3), and retighten screw (2). Refit the rotor arm and cap.

Renew worn or damaged points when required.

#### Carburetor Dampers (Fig. 68)

Every 6,000 miles (10,000 km.) unscrew and withdraw the plug and damper assembly from the top of each carburetor. Top-up the damper chambers with the seasonal grade of engine oil. The oil level is correct when utilising the damper as a dipstick its threaded plug is  $\frac{1}{4}$ " (6 mm.) above the dash pots, when resistance is felt. Refit the damper.

Using an oil can, apply oil to the throttle and choke control linkages.

#### Fan Belt Adjustment (Fig. 70)

Every 12,000 miles (20,000 km.) slacken the pivot bolt nut (1) and the adjustment bracket bolt (2). Pivot the alternator away from the engine until the belt can be moved  $\frac{3}{8}$ "—1" (19—25 mm.) at the mid-point of its longest run. Maintaining the alternator in this position, tighten the bolt (2) and nut (1).

#### Transmission (Fig. 71)

Every 6,000 miles (10,000 km.) with the vehicle standing on level ground, remove the oil filler plug (shown arrowed), and

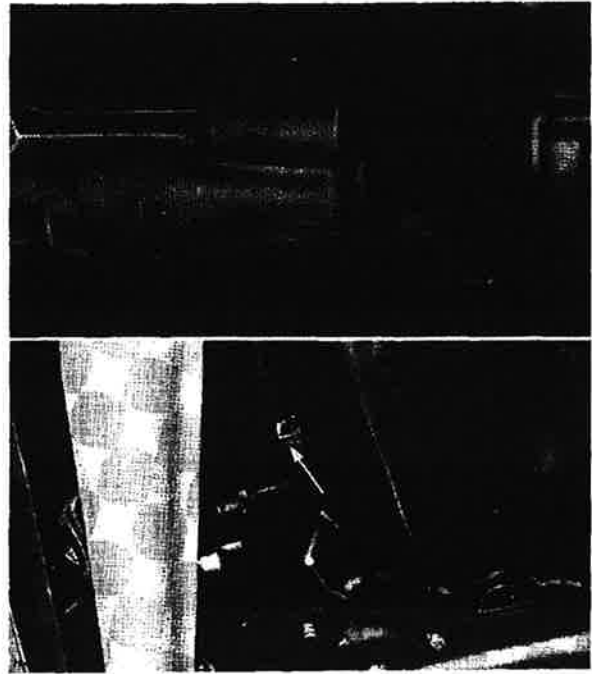

Fig. 71 (upper) Fig. 72 (lower)

53

## REGULAR MAINTENANCE

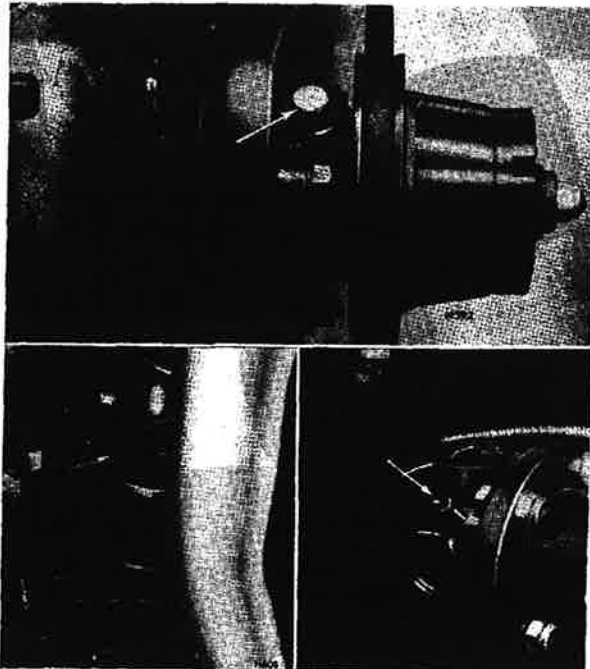

Fig. 73 (left) Fig. 74 (upper) Fig. 75 (right)

54

top up the transmission until the oil is level with the bottom of the filler plug threads. Allow surplus oil to drain away before refitting the plug and wiping clean. An oil transfer hole between the transmission and overdrive unit provides a common oil level. Maintenance of the overdrive unit is thus limited to ensuring that the correct oil level is maintained in the gearbox.

#### Final Drive (Fig. 72)

Every 6,000 miles (10,000 km.) remove the oil level plug (shown arrowed), and top-up the rear axle until the oil is level with the bottom of the filler plug threads. Allow surplus oil to drain before refitting the plug and wiping clean.

#### Propellor Shaft (Fig. 73)

Every 12,000 miles (20,000 km.) check the coupling bolts for tightness.

#### Water Pump (Fig. 74)

Every 12,000 miles (20,000 km.) remove the sealing plug from the water pump and replace it by a grease nipple ( $\frac{1}{8}$ " Briggs taper). Apply a grease gun until grease exudes from a pressure release hole in the side of the water pump. Replace the sealing plug.

#### Imer Drive Shafts (Fig. 75)

Every 6,000 miles (10,000 km.) apply a grease gun filled with grease to the nipple (arrowed) and give 5 strokes only.

Every 12,000 miles (20,000 km.) check the coupling bolts for tightness.

**Steering Unit (Fig. 77)**

Every 12,000 miles (20,000 km.) remove a sealing plug from the top of the steering unit and replace it by a grease nipple ( $\frac{1}{4}$ " B.S.P. Parallel). Apply the grease gun and give 5 strokes only. Remove the nipple and refit the plug.

**Lower Steering Swivel (Fig. 78)**

Every 6,000 miles (10,000 km.) remove the plug (arrowed). Fit a grease gun until oil exudes from the swivel. Remove the nipple and refit the plug.

**Upper Ball Joint (Fig. 76)**

Every 6,000 miles (10,000 km.) apply a grease gun filled with grease to the nipple (arrowed). Pump the gun until grease exudes from the underside of the nylon washer retained by the grease nipple.

**Tightness Check**

Every 12,000 miles (20,000 km.) check and if necessary, tighten the steering unit attachments and "U" bolts, steering tie rods and levers.

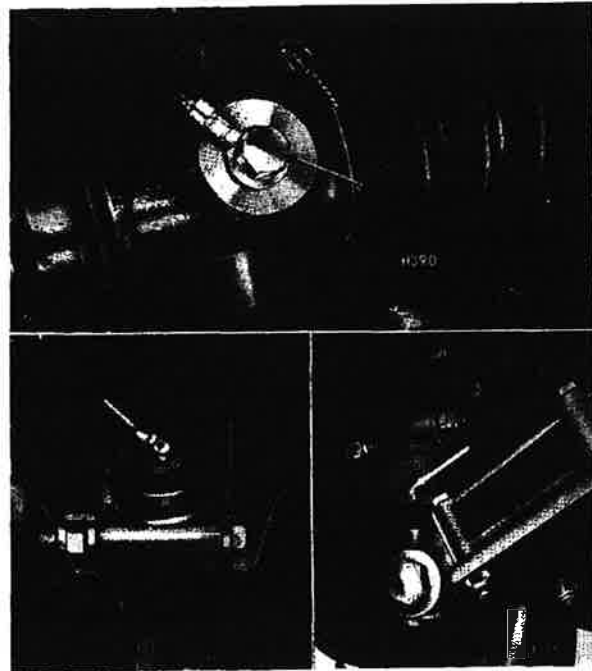

Fig. 76 (left) Fig. 77 (upper) Fig. 78 (right)

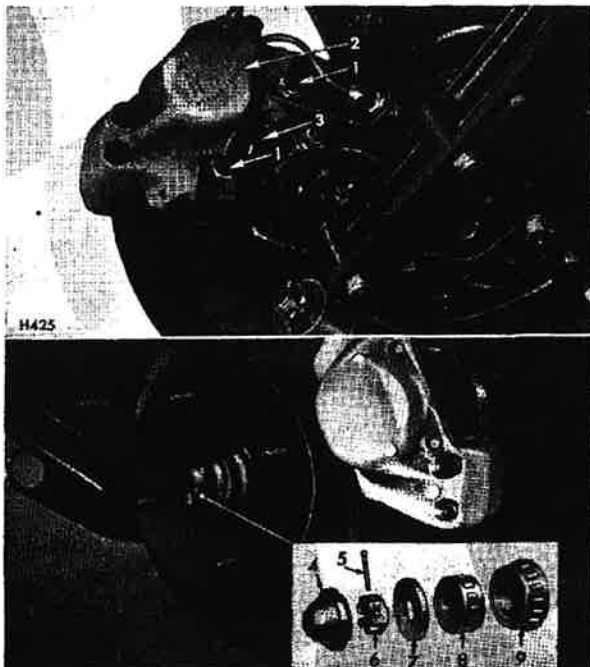

Fig. 79 (upper) Fig. 80 (lower)

**Front Hub Adjustment and Lubrication (Figs. 79 and 80)**

Every 12,000 miles (20,000 km.) check and if necessary adjust the front hubs.

At major overhaul periods, re-pack the front hubs with grease.

Jack up the front of the car and remove one front road wheel. Unscrew two bolts (1) securing the caliper (2) to the disc mounting plate (3).

Lift the caliper from the disc tying it to a convenient point to prevent it hanging by the attached hydraulic pipe. Note the number of shims fitted between the caliper and the vertical link.

When wire-spoked wheels are fitted, remove the splined hub extensions by detaching the nuts.

Remove the hub grease cap (4), withdraw the split pin (5) and remove the slotted nut (6) and "D" washer (7). Detach the hub assembly from the stub axle. Remove outer (8) and inner (9) race from the hub (inset Fig. 80). Wash all trace of grease from the hub bearings. Pack the hub bearings with new grease, working it well into the rollers.

Re-assemble the hub and races to the stub axle, securing them with the "D" washer and slotted nut. Spin the hub and tighten the nut until resistance is felt to hub rotation, then slacken off the nut one half flat and fit a new split pin. Re-assemble the brake caliper unit to the vertical link, refitting any shims removed during dismantling. Re-assemble the splined hub extension (if fitted). Refit the road wheel and lower the jack.

Repeat the above operations with the opposite wheel hub.

#### Exhaust System

Every 12,000 miles (20,000 km.) check the complete exhaust system for leaks and immediately rectify defects.

#### Wheel Alignment

Every 6,000 miles (10,000 km.) check the front and rear wheel track alignment if tire wear is uneven.

#### Electrical

Every 6,000 miles (10,000 km.) check the operation of all electrical equipment and adjust, if necessary, the headlight settings.

#### Brakes

The brakes are hydraulically operated and vacuum-servo assisted. Self-adjusting disc brakes are fitted to the front; leading and trailing shoe drum brakes are fitted at the rear of the car. The handbrake lever is connected to the rear brakes only, by twin cables.

Every 6,000 miles (10,000 km.) check and adjust the brakes as necessary.

Every 12,000 miles (20,000 km.) check the front wheels, jack up the rear of the car and remove both road wheels and brake drums. Examine the brake linings for wear and freedom from oil or grease. Renew worn or contaminated linings.

Using compressed air, blow all dust from the mechanism and, using a dry clean cloth, wipe the dust from the inside of the drums. Avoid touching the braking surfaces with greasy hands.

Refit the brake drums and road wheels, re-adjust the brakes and remove the jack.

57

## REGULAR MAINTENANCE

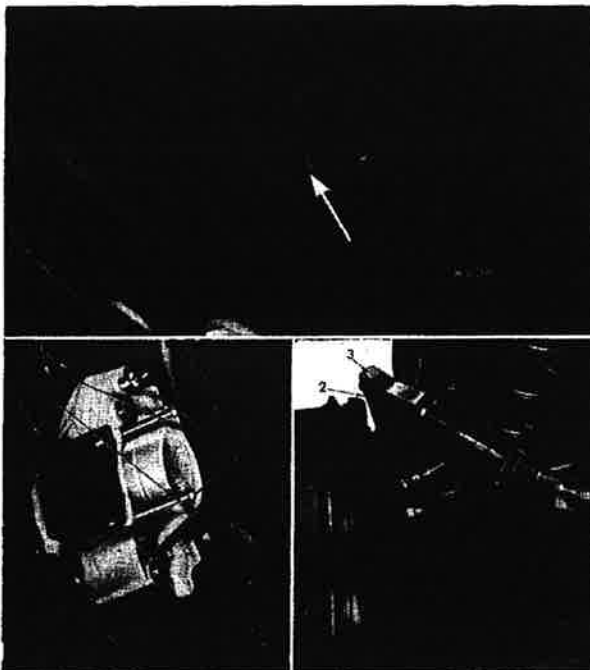

Fig. 81 (left) Fig. 82 (upper) Fig. 83 (right)

58

#### Front Brakes—Renewing Friction Pads (Fig. 81)

When friction pads are reduced to  $\frac{1}{8}$ " (3 mm.) thickness, or if they are of insufficient thickness to ensure safe braking for a further 6,000 miles (10,000 km.) renew them as follows:

1. Apply the handbrake, jack up the front of the car and remove the front road wheels.
2. Release the retaining clips (1) and remove the pad retaining pins (2).
3. Lift the friction pads (3) and the anti-squeal plates (4) from the caliper.

**IMPORTANT.** Do not depress the brake pedal with the pads removed.

4. Clean the exposed faces of the pistons and the recesses into which the pads fit, then carefully push the pistons back into the calipers.

**NOTE.** This action will displace fluid back into the master cylinder reservoir. To prevent over-flowing, syphon off surplus fluid.

5. Fit the brake pads and anti-squeal plates, ensuring that the arrows on the plates are pointing in the direction of wheel rotation.

6. Insert the pad retaining pins and secure them with the spring clips.
7. Pump the brake pedal several times to adjust the brakes and check the level of fluid in the reservoir.
8. Replace the front wheels and remove the jack.

**Rear Brakes—Adjusting (Fig. 82)**

Each rear brake is provided with an adjuster which is accessible when the rear road wheel is removed. To adjust the shoes, turn the adjuster clockwise until the shoes are hard against the drum, then slacken the adjuster by one notch increments until the drum is free to rotate.

**Parking Brake—Adjusting (Fig. 83)**

The parking brake is automatically adjusted when the rear drum brakes are adjusted; however, remove slackness, accruing in the cables by the following procedure:

1. Release the parking brake lever, chock the front wheels, jack up the rear of the car and remove the rear road wheels.
2. Detach the fork end (1) from the lever (2) by removing the clevis pin (3) which is secured by a split pin.
3. Adjust the brake shoes hard against the drum.

4. Slacken the locknut (4) and turn the fork end clockwise to reduce the effective length of the cable.
5. Adjust both cables equally until the clevis pins can be inserted without tension on the brake cables or the backplate levers.
6. Slacken the adjuster until the drums are free to rotate.
7. Tighten the locknut and replace the fork-end, clevis pin, split pin and washer. Apply a little grease around the fork ends, replace wheels and remove the jack.

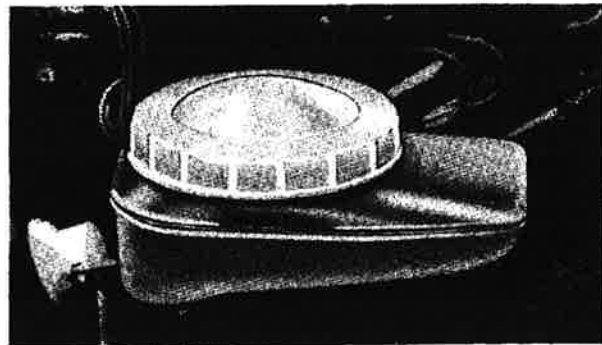

Fig. 84

REGULAR MAINTENANCE

**Vacuum Servo Unit**

The TR6 is fitted with a brake servo unit, which, utilising engine manifold depression multiplies the effort applied to the brake pedal.

The servo unit is in direct line between the pedal and the master cylinder. The system is arranged so that if, for any reason, the servo system is inoperative braking can still be effected, though requiring greatly increased pedal effort.

**CAUTION:** For reasons given above, it is extremely dangerous to "coast" or manoeuvre the car without the engine running.

**HYDRAULIC SYSTEM**

**Description**

The foot operated hydraulic braking system employs a tandem master cylinder for transmitting pressure to independent front and rear braking systems. Both systems are connected to opposing sides of a pressure differential warning actuator (P.D.W.A.) which operates an electrical switch when a pressure drop on one side of the valve causes a shuttle to move from its mid-position. The P.D.W.A. switch operates a warning light on the fascia (Fig. 2) which is series/parallel connected with the oil warning light. Thus when the brakes are working correctly, the brake warning light and the oil warning light are both

extinguished as the engine speed is increased from idle (giving regular assurance that the brake warning light is functioning). In the event of a partial brake failure the brake warning system is earthed directly, causing the warning light to glow brightly.

**Bleeding the Hydraulic Braking System  
General**

If air has entered either of the hydraulic braking systems then only the system affected need be bled. During bleeding, exercise care, as described in the following procedure, to avoid moving the shuttle from its mid-position. However, if the shuttle has moved during bleeding or subsequent to a fault condition, centralise the shuttle by performing operations 5—9 overleaf.

**Preparation for Bleeding**

Before commencing to bleed the brakes ensure that all the bleed nipples (Figs. 81 and 83) are clean and, taking care to avoid dirt entering the fluid reservoir, remove its filler cap and top-up with new hydraulic fluid. During the bleeding operation keep the level of the fluid above the dividing partition in the reservoir. Do not use fluid bled from the system for topping-up.

Use new fluid from a sealed container, resealing the container after use.

**Procedure**

Commence with the brake, of the pair being bled, farthest from the master cylinder. If both systems are to be bled, bleed the rear brakes first. When bleeding the rear brakes, release the handbrake and turn the brake adjusters to lock the shoes against the drums. When bleeding is completed adjust the brakes as detailed on page 59.

1. Attach a rubber tube of approx.  $\frac{1}{4}$ " (6 mm.) bore to the brake bleed nipple allowing the other end of the tube to hang submerged in a jar containing a quantity of clean brake fluid.
2. Unscrew the bleed-screw enough to allow the fluid to be pumped out (half a turn is normally sufficient).
3. Depress the brake pedal and allow it to return slowly noting that only a LIGHT pedal effort is required and the pedal must NOT be pushed through at the end of the stroke. (In addition, never "try" the pedal until all air has been dispelled and the system is fully bled, as either action will cause the shuttle to move and actuate the switch). Pausing between each depression of the pedal, continue pumping until all air has been dispelled from the bleed-screw (denoted by the absence of bubbles in the fluid being pumped into the jar).
4. With the pedal depressed, close the bleed-screw nipple and repeat the operation on the other brake.

**Procedure for Re-centralising the P.D.W.A. Piston**

If, for reasons described above, the P.D.W.A. shuttle requires to be re-centralised, adopt the following procedure.

5. Fit a rubber tube, as described in 1 above, to a brake bleed-screw at the opposite end of the car to that which has just been bled.
6. Open the bleed-screw.
7. Switch the ignition on but **DO NOT START THE ENGINE**. (The brake warning light will glow but the oil warning light will remain extinguished).
8. Exert a steady pressure on the brake pedal until the brake light dims and the oil light glows. (A click should be felt on the pedal as the shuttle returns to its mid-position).
9. Tighten the bleed-screw.

**NOTE:** If the pedal has been pushed too hard the shuttle will move to the other side of the valve, thus requiring the procedure to be repeated on a brake at the opposite end of the car.

61

**REGULAR MAINTENANCE****Clutch and Brake Pipe Hoses**

Every 6,000 miles (10,000 km.) examine and renew defective hoses. Ensure that pipes and hoses have adequate clearance to prevent chafing against other components, particularly when the steering is turned to "full lock" in either direction.

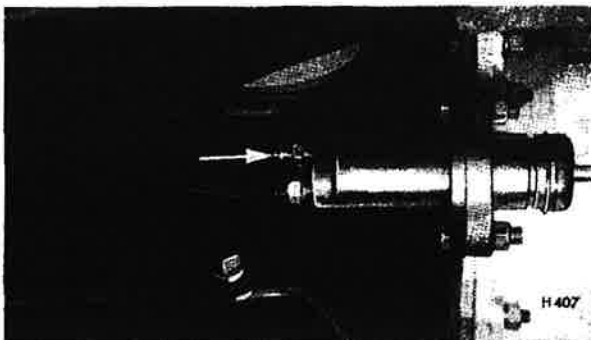

Fig. 85

62

**Bleeding the Clutch System (Figs. 58 and 85)**

When a pipe joint has been disconnected, or part of the hydraulic clutch system dismantled, bleed all air from the system as follows:

1. Clean the neck and cap of the master cylinder.
2. Remove the cap and top-up with new hydraulic fluid. (At no time, during the subsequent operation, allow the level of fluid to fall below half full).
3. Clean the clutch cylinder nipple (Fig. 85) and attach to it a rubber tube of approx.  $\frac{1}{4}$ " (6 mm.) bore allowing the other end of the tube to hang submerged in a jar containing a quantity of clean hydraulic fluid.
4. Unscrew the bleed nipple enough to allow fluid to be pumped out (a half turn is normally sufficient).
5. Depress the clutch pedal firmly and allow it to return unassisted. Pausing between each depression continue pumping until all air has been expelled from the system (denoted by the absence of bubbles in the fluid being pumped into the jar).
6. With the pedal depressed, close the bleed nipple.



## RECOMMENDED LUBRICANTS AND ANTI-FREEZE SOLUTIONS

(The products recommended are not listed in order of preference)

COMPONENT	AIR/TEMP.		API DESIGNATION	BP	CASTROL	DUCKHAM'S	ESSO		MOBIL	PETROFINA	SHELL	TEXACO CALTEX	
	°C.	°F.											
** ENGINE CARBURETOR DAMPERS AND OIL CAN	Over 0	Over 30	MM or MS	*BP Super Visco-Static	Castrol XLR or Castrol XL	Q20-50	Q10-30	Eso Extra Motor Oil 20W/40	Unifilo	Mobiloil Super 10W/50 or Mobiloil Special 20W/50	Fina Super-grade Motor Oil SAE 20W/50	*Super Shell Motor Oil	Havoline 20W/40
	Below 0	Below 30	MM or MS		Castrolite	Q5500				Eso Extra Motor Oil 10W/30			Mobiloil Super 10W/50
TRANSMISSION OVERDRIVE AND REAR AXLE	Over 0	Over 30	GL4	BP Gear Oil SAE 90 EP	Castrol Hypoy	Duckham's Hypoid 90	Eso Gear Oil GX 90	Mobilube GX	Mobilube GX	Fina Pontonic MP SAE 90	Shell Spirax 90 EP	Multigear Lubricant EP90	
	Below 0	Below 30	GL4	BP Gear Oil SAE 80 EP	Castrol Hypoy 80	Duckham's Hypoid 80				Eso Gear Oil GX 80			Mobilube GX 80
FRONT AND REAR HUBS BRAKE CABLES GREASE GUN				BP Energrease L2	Castrol MP Grease	Duckham's LB 10	Eso Multi-purpose Grease H	Mobilgrease MP	Fina Marson HTL 2	Shell Darinax Ax	Marfak All Purpose		

\* Oils marked thus are available in Multigrade forms with viscosity characteristics appropriate to the ambient temperature range in individual markets  
 \*\* WHERE CIRCUIT RACING OR OTHER SEVERE COMPETITIVE EVENTS ARE CONTEMPLATED IT IS ADVISABLE, IN VIEW OF THE INCREASED OIL TEMPERATURE ENCOUNTERED, TO USE OILS OF HIGH VISCOSITY

CLUTCH AND BRAKE RESERVOIRS	CASTROL GIRLING BRAKE AND CLUTCH FLUID CRIMSON. WHERE THIS PROPRIETARY BRAND IS NOT AVAILABLE, OTHER FLUIDS WHICH MEET SAE J1703 SPECIFICATION MAY BE USED										
APPROVED ANTI-FREEZE SOLUTIONS	Smith's Bluecol	BP Anti-Frost	Castrol Anti-Freeze	Duckham's Anti-Freeze	Eso Anti-Freeze	Mobil Permzone	Fina Thermidor	Shell Zeez Anti-Freeze	Startex		
	WHERE THESE PROPRIETARY SOLUTIONS ARE NOT AVAILABLE, OTHERS WHICH MEET BSI 3151 or 3152 SPECIFICATION MAY BE USED										

## LUBRICATION CHART

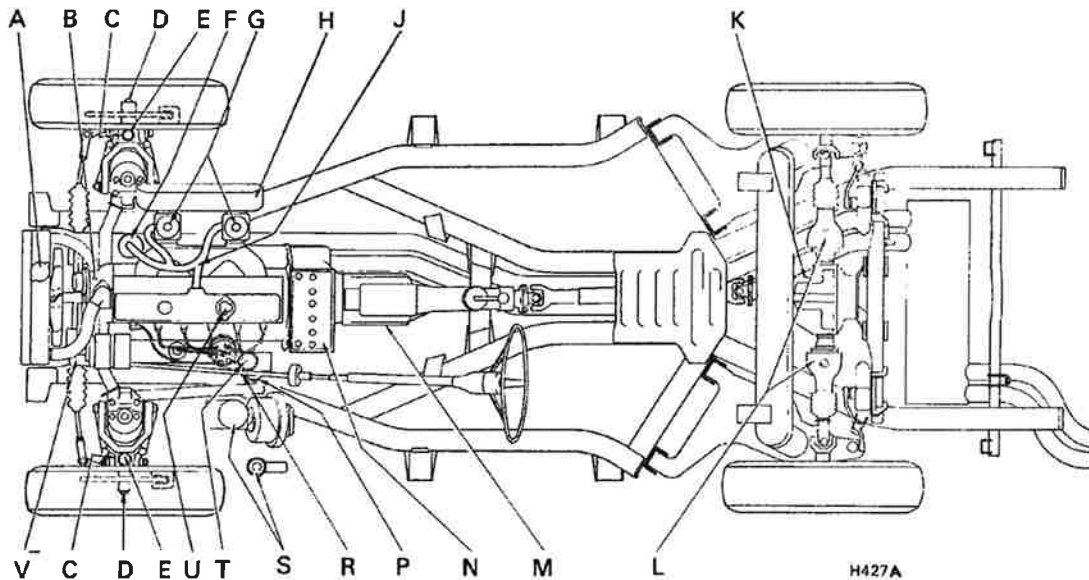

Fig. 86

## MAINTENANCE CHART

Chart Ref.	Items	Details	Page Ref.		Intervals × 1000			
					Miles	Kms.	Miles	Kms.
A	Radiator	Top up	45	Weekly				
B	Water Pump	Grease	54	—			12	20
C	Upper Ball Joints	Grease	55	—	6	10		
D	Front Hubs	Adjust	56	—			12	20
E	Lower Steering Swivels	Grease	55	—	6	10		
F	Evaporation Canister	Renew element	52				12	20
		Renew canister	52	48,000 miles				
G	Carburettor Dampers	Top up	53	—	6	10		
H	Air Cleaners	Clean	49	—	6	10		
		Renew element	49	—			12	20
J	Breather Piping	Clean	52	—			12	20
K	Final Drive	Top up	54	—	6	10		
L	Drive Shafts	Grease	54	—	6	10		
M	Gearbox	Top up	53	—	6	10		
N	Battery	Top up	46	Monthly				
P	Oil Filter	Renew element	48	—			12	20
R	Fuel Filter	Renew	51	—	6	10		
S	Master Cylinder—Brake Master Cylinder—Clutch	Check	45	Weekly				
		Top up	46	Monthly				
T	Fuel Pump	Clean	51	—			12	20
U	Engine Oil Pan	Top up	45	Daily				
		Drain and refill	48	—	6	10		
V	Steering Unit	Grease	55	—			12	20

65

### GENERAL SPECIFICATION

### GENERAL SPECIFICATION

#### Engine

Number of cylinders	6	
Bore of cylinders	74.7 mm.	2.94 in.
Stroke of crankshaft	95 mm.	3.74 in.
Cubic capacity	2498 c.c.	152 in. <sup>3</sup>
Piston area	263 cm. <sup>2</sup>	40.7 in. <sup>2</sup>
Compression ratio	8.5 : 1	
Valve rocker clearances (cold)	0.25 mm.	0.010 in.
Valve timing	Inlet and exhaust equally open at T.D.C.	

#### Lubrication (Engine)

Pump	High capacity eccentric lobe type
Filter	Replaceable flow type

#### Cooling System

	Pressurised "no loss" system incorporating a translucent plastic overflow bottle
Circulation	"Vee" belt driven pump
Fan	8 blades, 12.5 in. dia. (31.6 cm.)

66

#### Fuel System

Pump	A.C. mechanically operated diaphragm type
Carburetor	Twin sidedraught Stromberg 175 C.D.S.E.
Manifolds	Cast aluminium inlet and twin outlet exhaust manifolds
Air cleaners	Replaceable paper elements
Crankcase breathing	Closed circuit—controlled by emission valve between rocker cover and manifold

#### Ignition System

Coil	Lucas HA12
Distributor—type	Lucas 22D6
contact gap	0.015 in. (0.4 mm.)
rotation—viewed on rotor	Anticlockwise
Firing order	1 - 5 - 3 - 6 - 2 - 4
Sparking plugs—type	Champion UN—12Y
gap	0.025 in. (0.63 mm.)
Ignition timing (static)	10 degrees B.T.D.C.
Ignition timing (idle)	4 degrees A.T.D.C.



## GENERAL SPECIFICATION

<b>Exterior Dimensions</b>			<b>Road Speed Data</b>							
Overall length	12 ft. 11 in.	3937 mm.	Engine speed at a road	O/D	O/D	O/D				
Width	4 ft. 10 in.	1470 mm.	speed of:	Top	Top	3rd	3rd	2nd	2nd	1st
Height with hood erected (unladen)	4 ft. 2 in.	1270 mm.	10 m.p.h.	395	482	525	641	794	969	1513
Height with hood folded (unladen)	3 ft. 10 in.	1170 mm.	10 k.p.h.	248	303	330	402	498	608	950
			Road speed at 1,000 r.p.m.	20-74 m.p.h.		33-04 k.p.h.				
<b>Weight (approx.)</b>			Road speed at 2,500 ft./min.							
Dry (excluding extra equipment)	2280 lbs.	1034 kg.	piston speed in top gear	83 m.p.h.		132 k.p.h.				
Complete (including fuel, oil, water and tools)	2390 lbs.	1084 kg.								
Maximum gross vehicle weight	2855 lbs.	1295 kg.								
Vehicle capacity weight	412 lbs.	187 kg.								

69

## INDEX

<b>INDEX</b>			
	<i>Page</i>		<i>Page</i>
Air cleaner .. .. .	49	Choke control .. .. .	10
Air distribution control .. .. .	12	Clutch bleeding .. .. .	62
Alternator .. .. .	33	Clutch master cylinder .. .. .	46
Ammeter .. .. .	10	Compression checks .. .. .	49
Anti-freeze .. .. .	29	Controls, instruments and indicators .. .. .	8
Ashtray .. .. .	9	Cooling system .. .. .	27
Battery .. .. .	33	Commission numbers .. .. .	4
Battery—Top-up .. .. .	46	Contact breaker points .. .. .	52
Beam aiming .. .. .	35	Cylinder head nuts .. .. .	50
Bleeding the brakes .. .. .	60	Dimensions .. .. .	69
Bleeding the clutch .. .. .	62	Dipstick .. .. .	45
Blower switch .. .. .	12	Disc brake pad .. .. .	58
Brake line failure indicator .. .. .	9	Distributor .. .. .	52
Brakes—Maintenance .. .. .	57	Driving recommendations .. .. .	39
Brake master cylinder .. .. .	45	Electrical .. .. .	30
Bulb chart .. .. .	34	Electrical checks .. .. .	57
Bulb renewal .. .. .	36	Electric arc welding .. .. .	56
Capacities .. .. .	68	Emission control system .. .. .	42
Carbon canister .. .. .	52	Engine breather pipes .. .. .	52
Carburetor dampers .. .. .	53	Engine—Daily check .. .. .	45
Care of bodywork .. .. .	22	Engine oil pan .. .. .	48
Charging system .. .. .	33	Evaporation control system .. .. .	42
Chassis data .. .. .	68	Exhaust system .. .. .	57
		Facia panel .. .. .	6
		Fan belt adjustment .. .. .	53
		Final drive .. .. .	54
		Firing order .. .. .	66
		Front brake pads .. .. .	58
		Front hub adjustment .. .. .	56
		Frost precautions .. .. .	29
		Fuel filler cap .. .. .	18
		Fuel filter .. .. .	52
		Fuel gauge .. .. .	10
		Fuel pump .. .. .	51
		Fuel—Recommended .. .. .	40
		Fuse system .. .. .	32
		Gear box .. .. .	53
		Gear shift lever .. .. .	12
		General specification .. .. .	66
		Glove box lock .. .. .	10
		Hard top .. .. .	21
		Hazard warning indicator .. .. .	9
		Hazard warning switch .. .. .	9
		Headlights .. .. .	35
		Headlight dipper .. .. .	13
		Heater control .. .. .	12
		High beam indicator .. .. .	13

## INDEX

	<i>Page</i>		<i>Page</i>		<i>Page</i>
Hood release .. .. .	18	Maintenance, regular .. .. .	47	Road speed data .. .. .	69
Horn push .. .. .	9	'No charge' indicator .. .. .	13	Routine servicing .. .. .	41
Hydraulic system .. .. .	60	Odometer .. .. .	13	Running in .. .. .	39
Ignition distributor .. .. .	52	Oil filter element .. .. .	48	Safety harness .. .. .	14
Ignition/starter switch .. .. .	10	Oil pressure gauge .. .. .	9	Screen washer .. .. .	20
Inner drive shafts .. .. .	54	Overdrive switch .. .. .	8	Scuttle vent control .. .. .	10
Instruments and indicators .. .. .	8	Overdrive unit .. .. .	40	Seats .. .. .	16
Instrument illumination .. .. .	36	Parking brake—Adjusting .. .. .	59	Service, 1,000 miles (Free) .. .. .	47
Instrument illumination rheostat	10	Parking brake lever .. .. .	12	Soft top .. .. .	19
Interior lamp .. .. .	13	Periodic checks .. .. .	45	Spare wheel .. .. .	25
Jacking of car .. .. .	24	Propellor shaft .. .. .	54	Sparking plugs .. .. .	51
Key warning system .. .. .	38	Radiator .. .. .	27	Speedometer .. .. .	8
Lamps .. .. .	36	Radio controls .. .. .	14	Steering unit .. .. .	55
Lifting jack .. .. .	24	Rear brake—Adjusting .. .. .	59	Sun visors .. .. .	14
Lighting switch .. .. .	9	Rear flasher and tail/stop lights ..	36	Tachometer .. .. .	9
List of sections .. .. .	5	Rear marker lights .. .. .	36	Temperature gauge .. .. .	9
Locks and keys .. .. .	17	Rear view mirror .. .. .	14	Tightness check .. .. .	55
Low oil pressure indicator .. .. .	13	Recommended fuel .. .. .	40	Tires .. .. .	23
Lower steering swivel .. .. .	55	Recommended lubricants .. .. .	63	Tonneau cover .. .. .	21
Lubricants—Recommended .. .. .	63	Regular maintenance .. .. .	47	Transmission .. .. .	53
Maintenance chart .. .. .	64	Reverse lights .. .. .	36	Trip odometer .. .. .	13
				Trip release control .. .. .	13
				Trunk locker .. .. .	18
					71

## INDEX

	<i>Page</i>		<i>Page</i>		<i>Page</i>
Turn signal control .. .. .	13	Valve clearance adjusting .. .. .	50	Wheels and tires .. .. .	23
Turn signal flasher unit—renew	38	Warning lights .. .. .	36	Windshield washer .. .. .	28
Upper ball joints .. .. .	55	Washing .. .. .	22	Windshield washer switch .. .. .	8
Vacuum servo .. .. .	60	Water pump .. .. .	54	Windshield wiper switch .. .. .	8
		Weights .. .. .	69	Wire wheels .. .. .	25
				Wiring diagram .. .. .	30

